

# BOOKAZINE LOW

BÜCHERSCHRANK - BIBLIOTHÈQUE - BOOKCASE

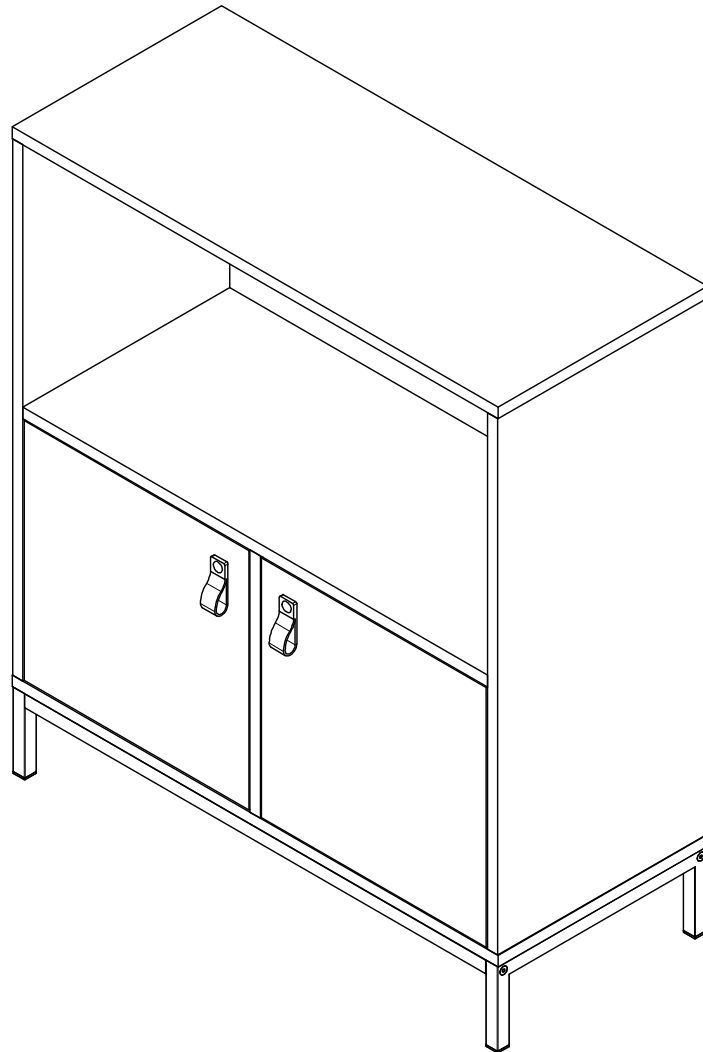

vtwonen

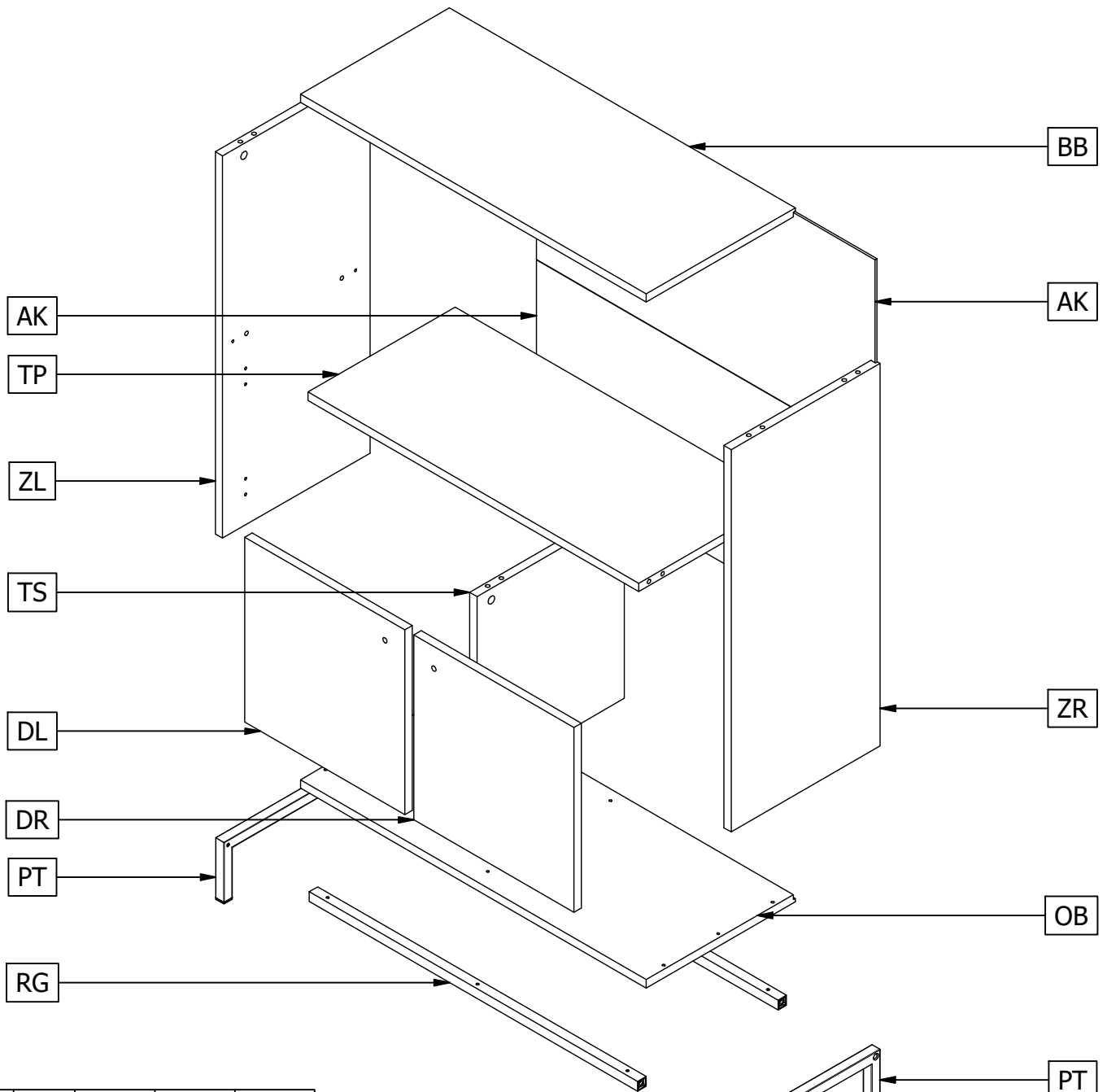

Qty	Code	Thickness	Length	Width
2	AK	4	397	795
1	BB	17	812	350
1	DL	17	376	376
1	DR	17	376	376
1	OB	17	812	350
1	TP	17	777	346
1	TS	17	380	346
1	ZL	17	777	350
1	ZR	17	777	350
Qty	Code	Thickness	Length	Width
2	PT	20	350	122
2	RG	20	771	20

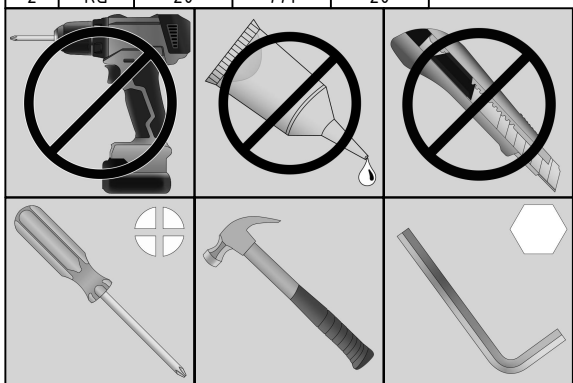



Nederlands

### WAARSCHUWING.

Voorkom dat dit meubel omvalt. Meubels die omvallen kunnen ernstig of levensbedreigend letsel veroorzaken. Het meegeleverde kantelbeslag dient daarom **BESLIST** te worden gebruikt om het meubel te bevestigen aan de muur.

Sta niet toe dat kinderen klimmen op lades, deuren of planken.  
Plaats zware voorwerpen altijd onderin.  
Zet zware voorwerpen nooit op het meubel.

Norsk

### ADVARSEL.

Unngå at dette møbelet faller. Møbler som faller kan forårsake alvorlige eller livstruende skader. Det medleverte beslaget skal derfor **ABSOLUTT** brukes for å feste møbelet til veggen.

Ikke tillat at barn klatrer på skuffer, dører eller planker.  
Plasser tunge objekter alltid nederst.  
Sett aldri tunge objekter på møbelet.

Deutsch

### WARNHINWEIS.

Verhindern Sie, dass dieses Möbelstück umstürzt. Möbel, die umfallen, können schwere oder lebensbedrohliche Verletzungen verursachen. Zur Befestigung des Möbelstücks an der Wand sollte daher **UNBEDINGT** die mitgelieferte Kippsicherung verwendet werden.

Erlauben Sie Kindern nicht, auf Schubladen, Türen oder Regale zu klettern.  
Stellen Sie schwere Gegenstände nur unten in das Möbelstück.  
Stellen Sie niemals schwere Gegenstände auf das Möbelstück.

Français

### ATTENTION.

Évitez que le meuble ne bascule. Les meubles qui basculent peuvent être à l'origine de blessures graves ou mortelles. La fixation anti-basculement fournie avec le meuble doit **OBLIGATOIREMENT** être utilisée pour fixer celui-ci au mur.

Ne laissez pas les enfants grimper sur les tiroirs, portes ou étagères.  
Placez toujours les objets lourds dans le bas du meuble.  
Ne placez jamais les objets lourds sur le meuble.

English

### CAUTION.

Prevent this furniture from falling over. Falling furniture could cause severe or life-threatening injuries. Therefore, the included tip-over restraint **HAS** to be used to secure the furniture to the wall.

Do not allow children to climb on the drawers, doors or shelves.  
Always place heavy objects at the bottom.  
Never place heavy objects on top of the furniture.

Svenska

### VARNING.

Förhindra att denna möbel välter. Möbler som välter kan orsaka allvarliga eller livshotande skador. Det medföljande tippskyddet **MÅSTE** därför användas för att förankra möbelen i väggen.

Låt inte barn klättra på lådor, dörrar eller hyllor.  
Placera alltid tunga föremål längst ned.  
Ställ aldrig tunga föremål på möbelen.

Polski

### UWAGA.

Zabezpiecz meble przed przewróceniem. Przewrócenie się mebli może spowodować poważne lub śmiertelne obrażenia ciała. Dlatego załączone ograniczniki przechyłu **ZDECYDOWANIE** powinny zostać wykorzystane do przymocowania mebla do ściany.











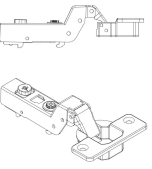
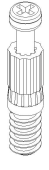

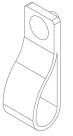
Nie pozwalaj dzieciom wspinać się na szuflady, drzwiczki lub półki.  
Zawsze umieszczaj ciężkie przedmioty w dolnej części.  
Nigdy nie stawiaj na meblu ciężkich przedmiotów.

Español

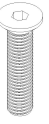
### ADVERTENCIA.

Evite que este mueble se caiga. Los muebles que se caen pueden ocasionar lesiones graves o potencialmente mortales. Por lo tanto, el herraje abatible suministrado debe utilizarse **SIN LUGAR A DUDAS** para fijar el mueble a la pared.

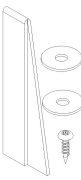
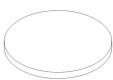
No permita que los niños se suban a los cajones, las puertas o los estantes.  
Los objetos pesados siempre deben colocarse en la parte inferior.  
Nunca coloque objetos pesados sobre el mueble.

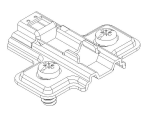
10	Ø15mm	AC000102 	4	15mm V	AC000463 
10	24mm	AC000103 	10	8x35mm	AC000601 
2	M4x15mm	AC000155 	2		AC005025-Z 
2	3x15mm	AC000201 	1	SW4	AC000216 
14	4x16mm	AC000204 	4	TL000107	TL000107 
9	5x40mm	AC000238 	2	Ø7x14.5	AC000394 
25	Ø1.4x25mm	AC000316 			
1	Safety Strip	AC000356 			
10	Ø14	AC000369- 			
2	19x14mm	AC000371 			
4	14mm H=2	AC000460 			

1

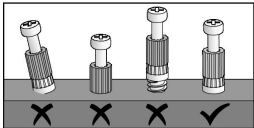
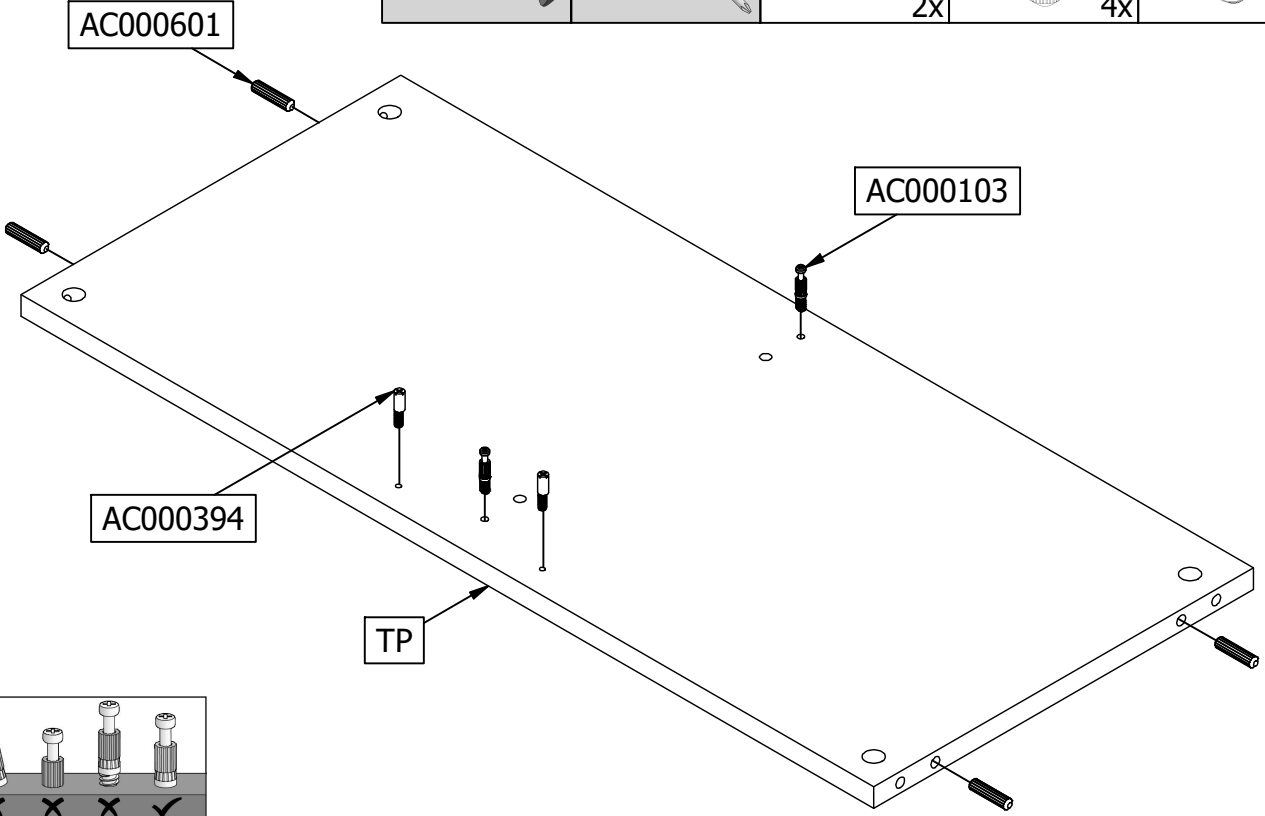
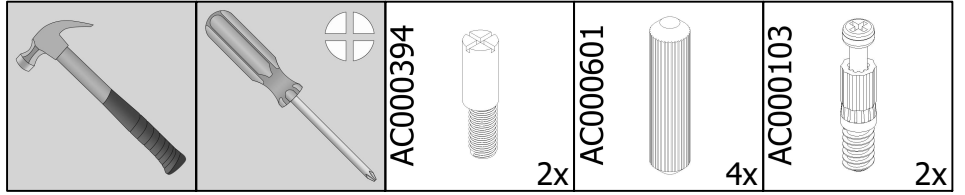

2

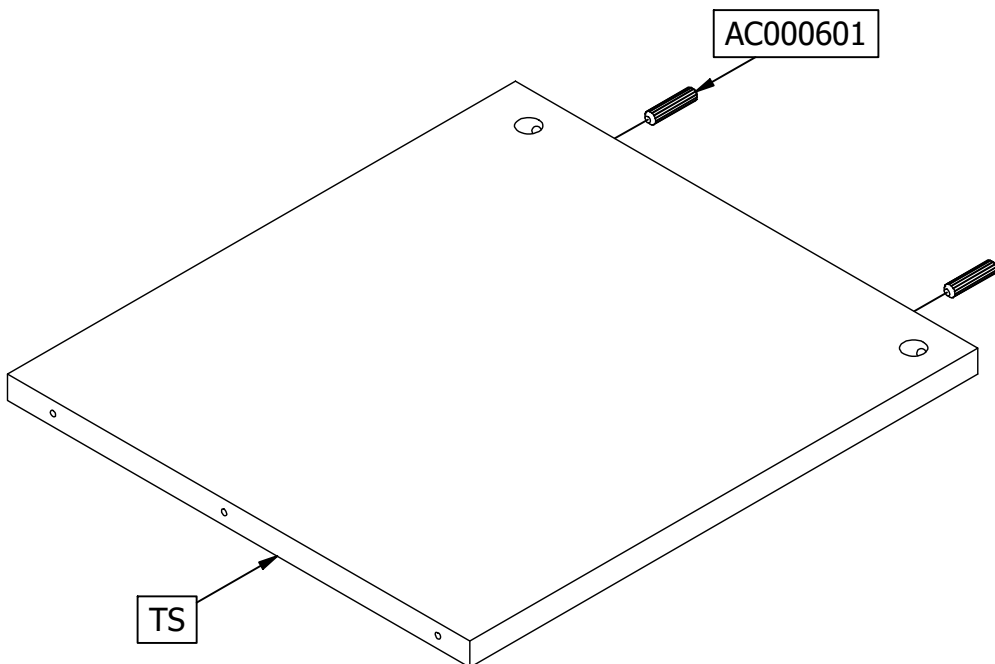
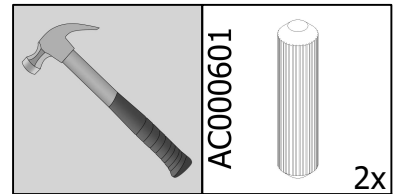

3

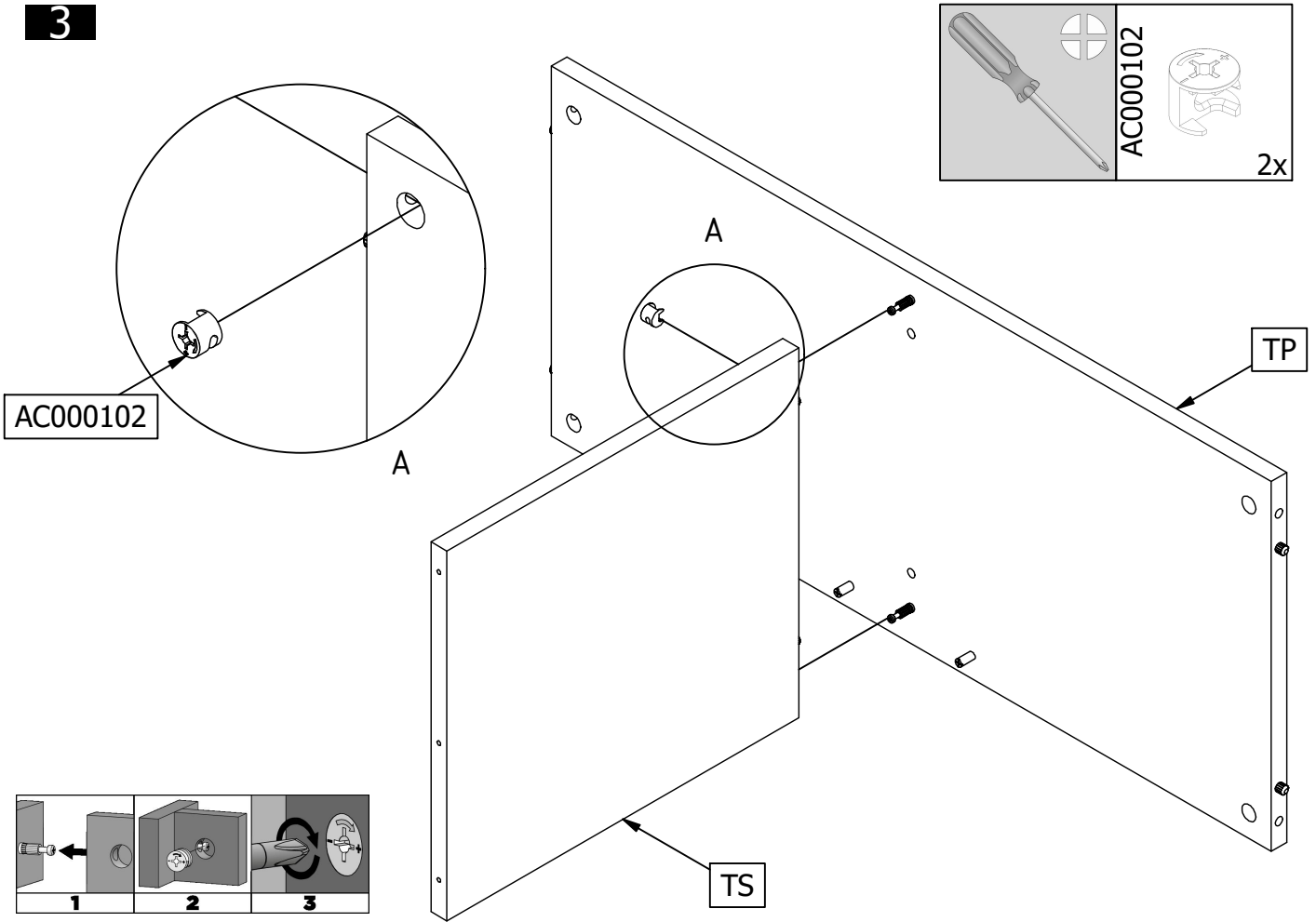

4

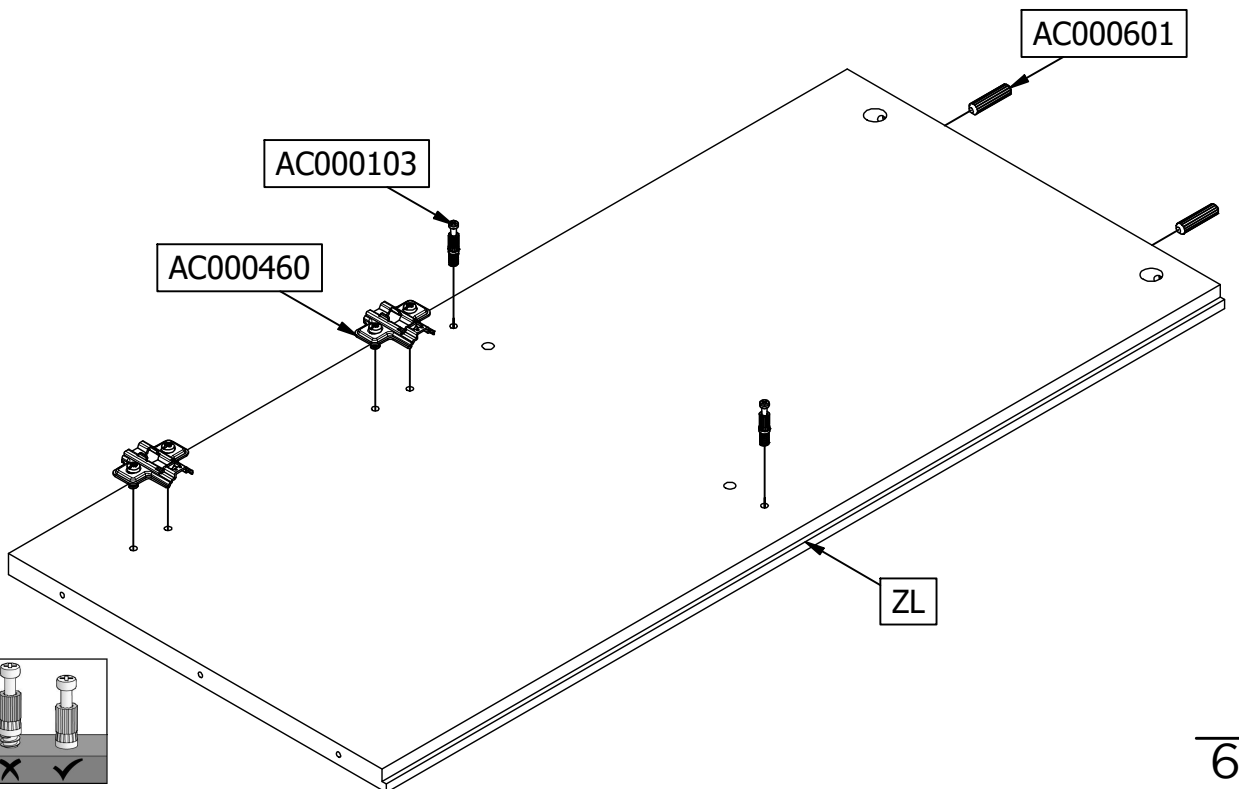
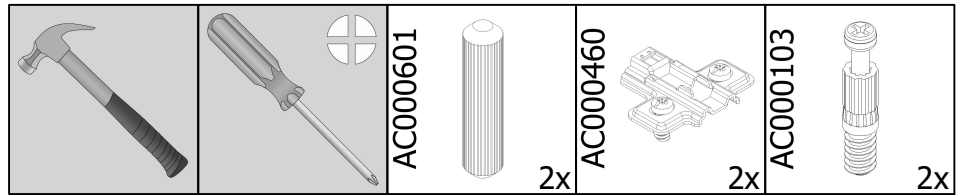

5

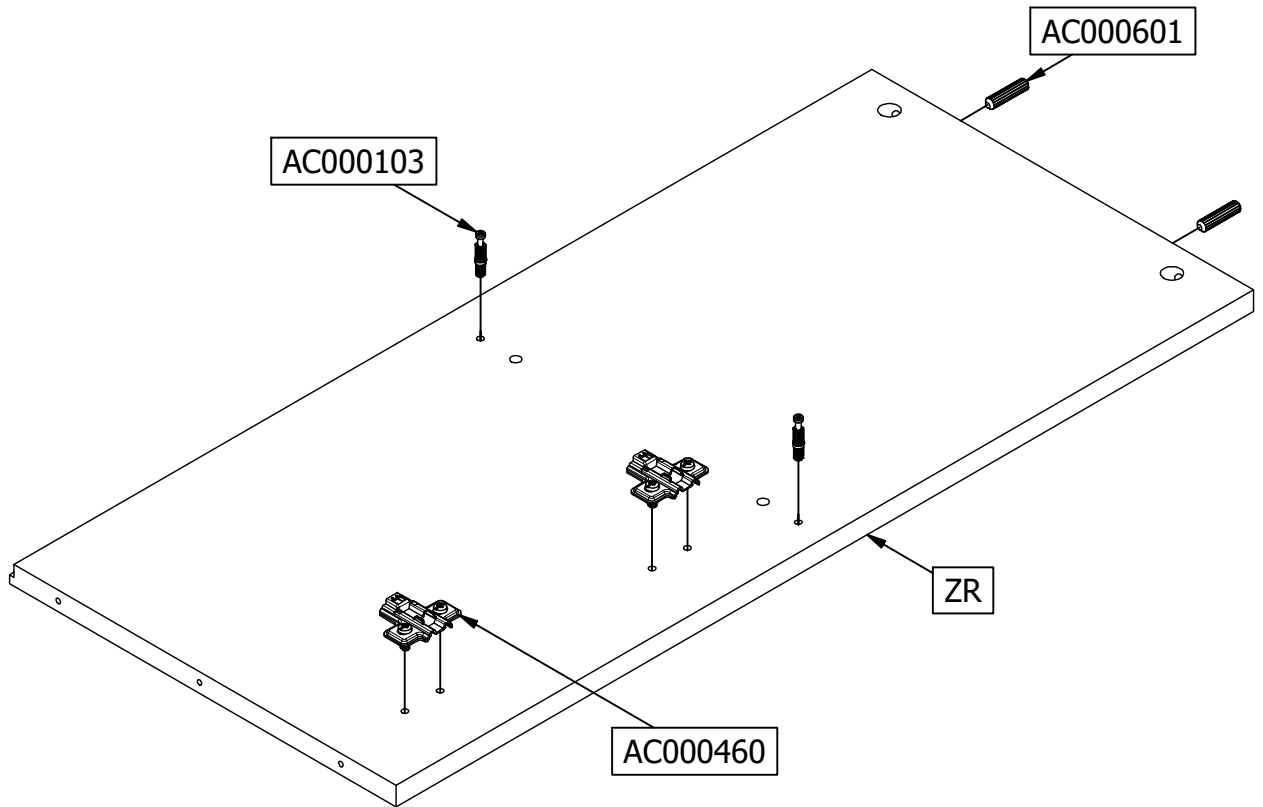
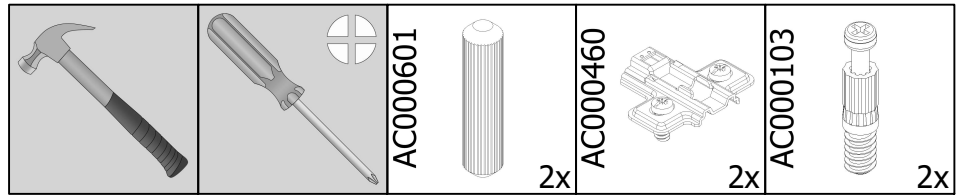
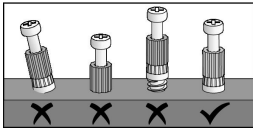

6

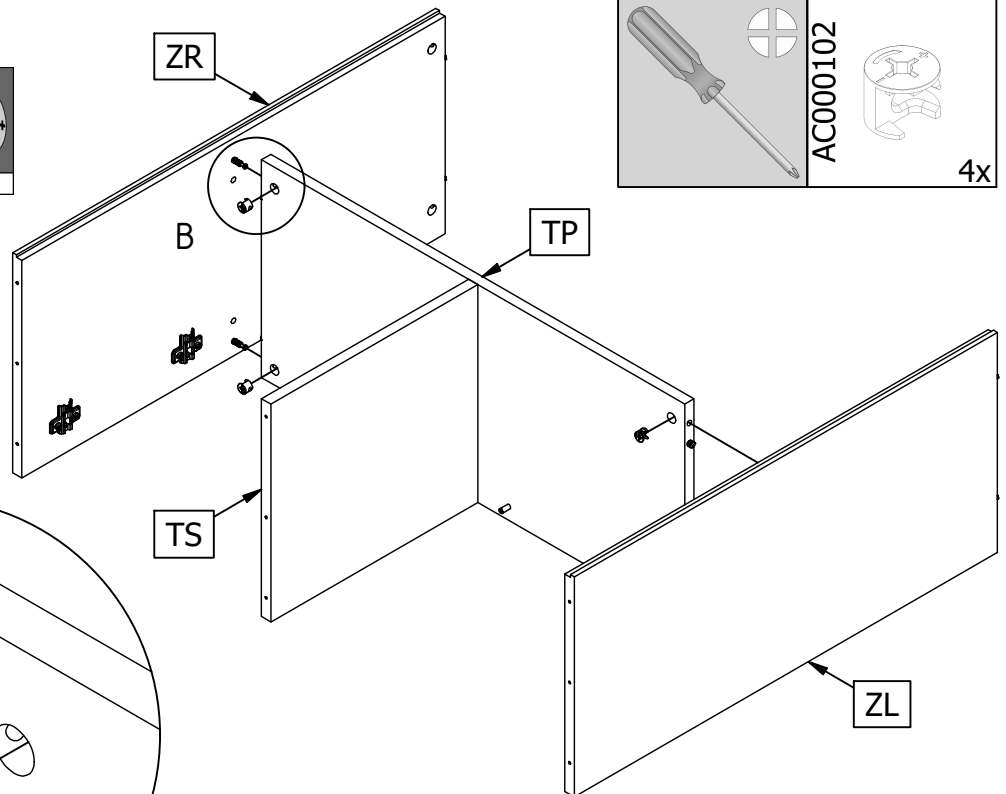
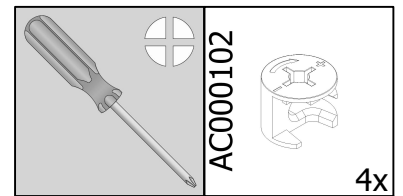
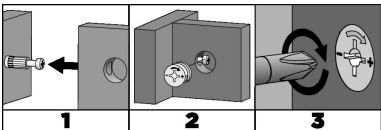

AC000102

B

7

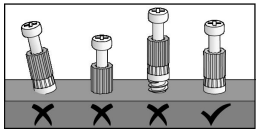
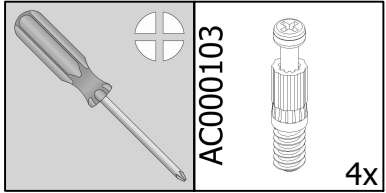
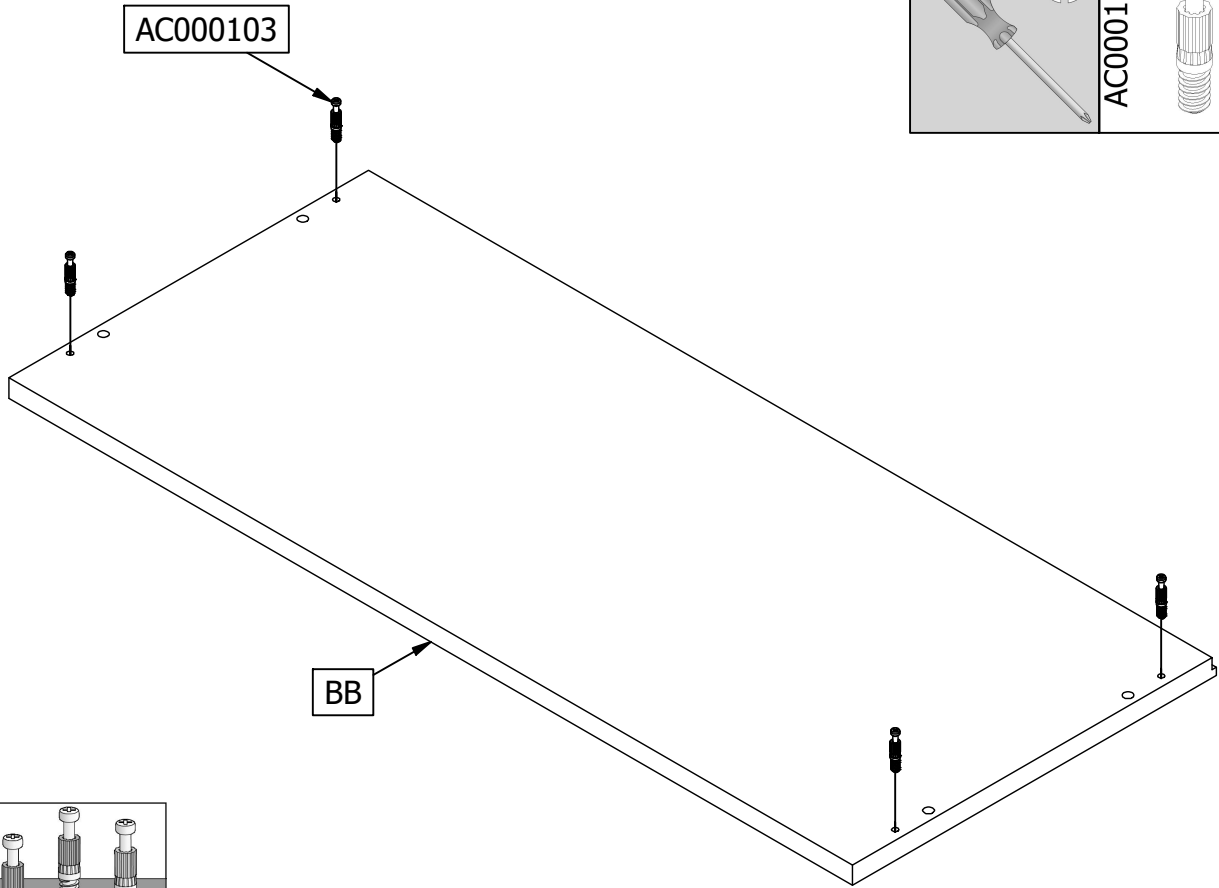

8

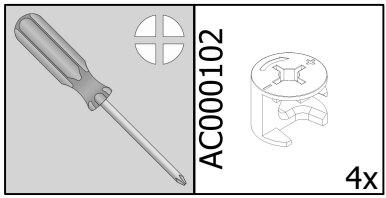
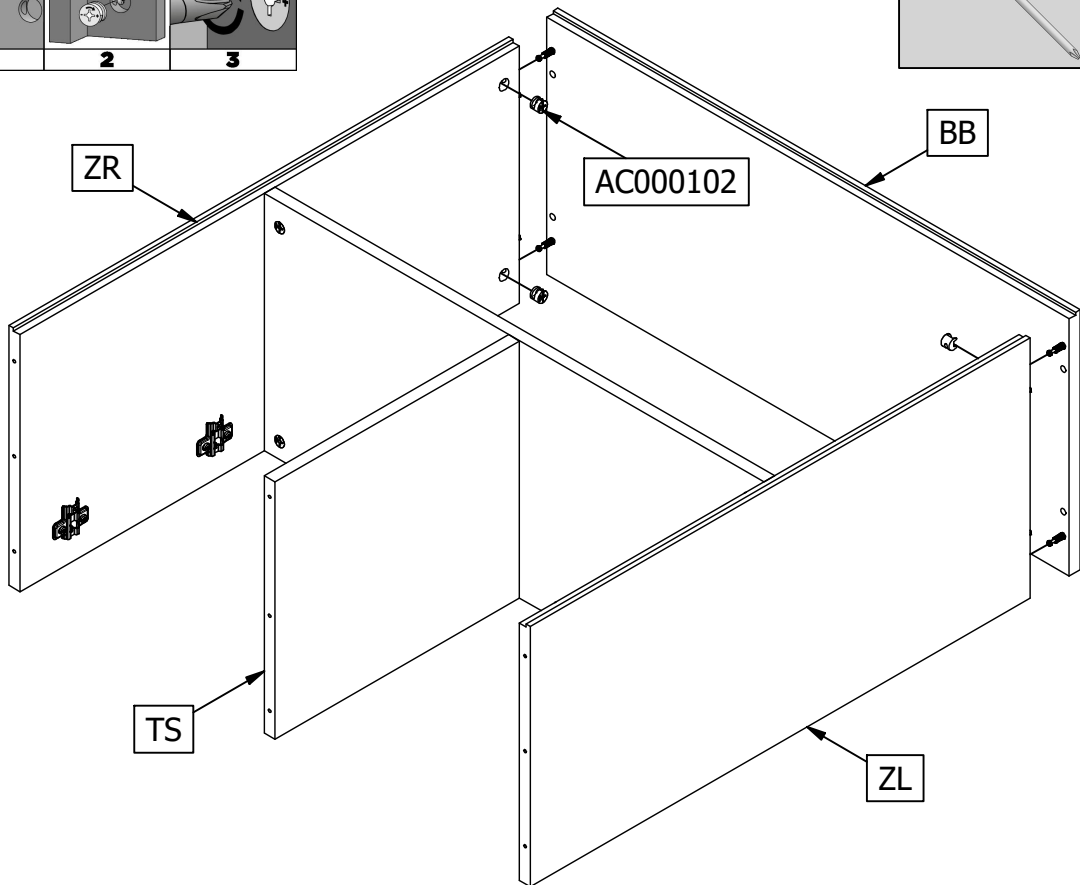
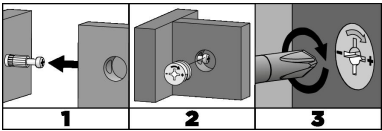



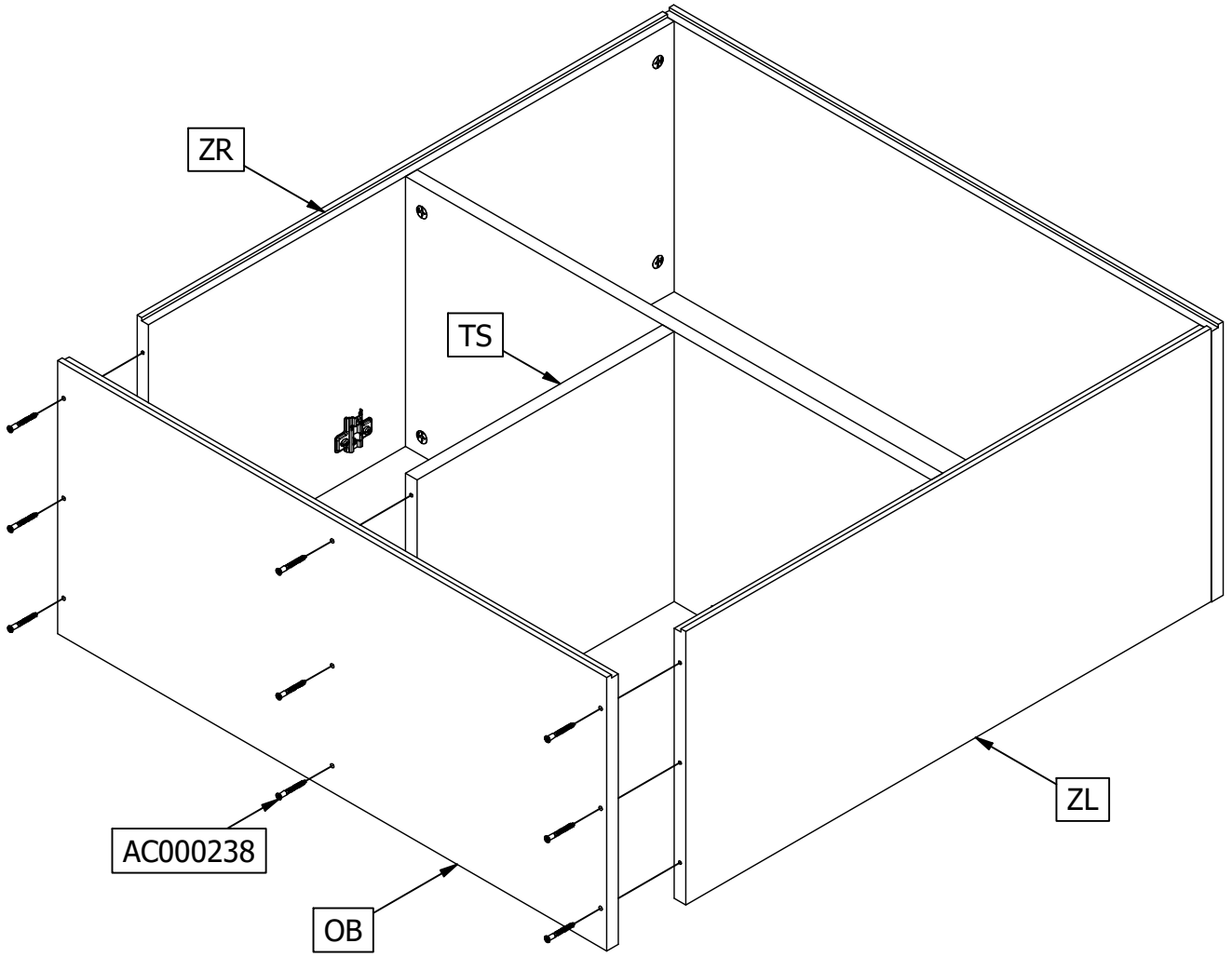
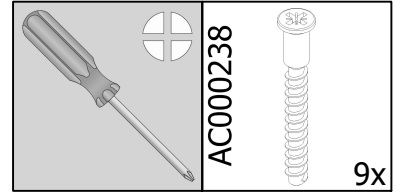

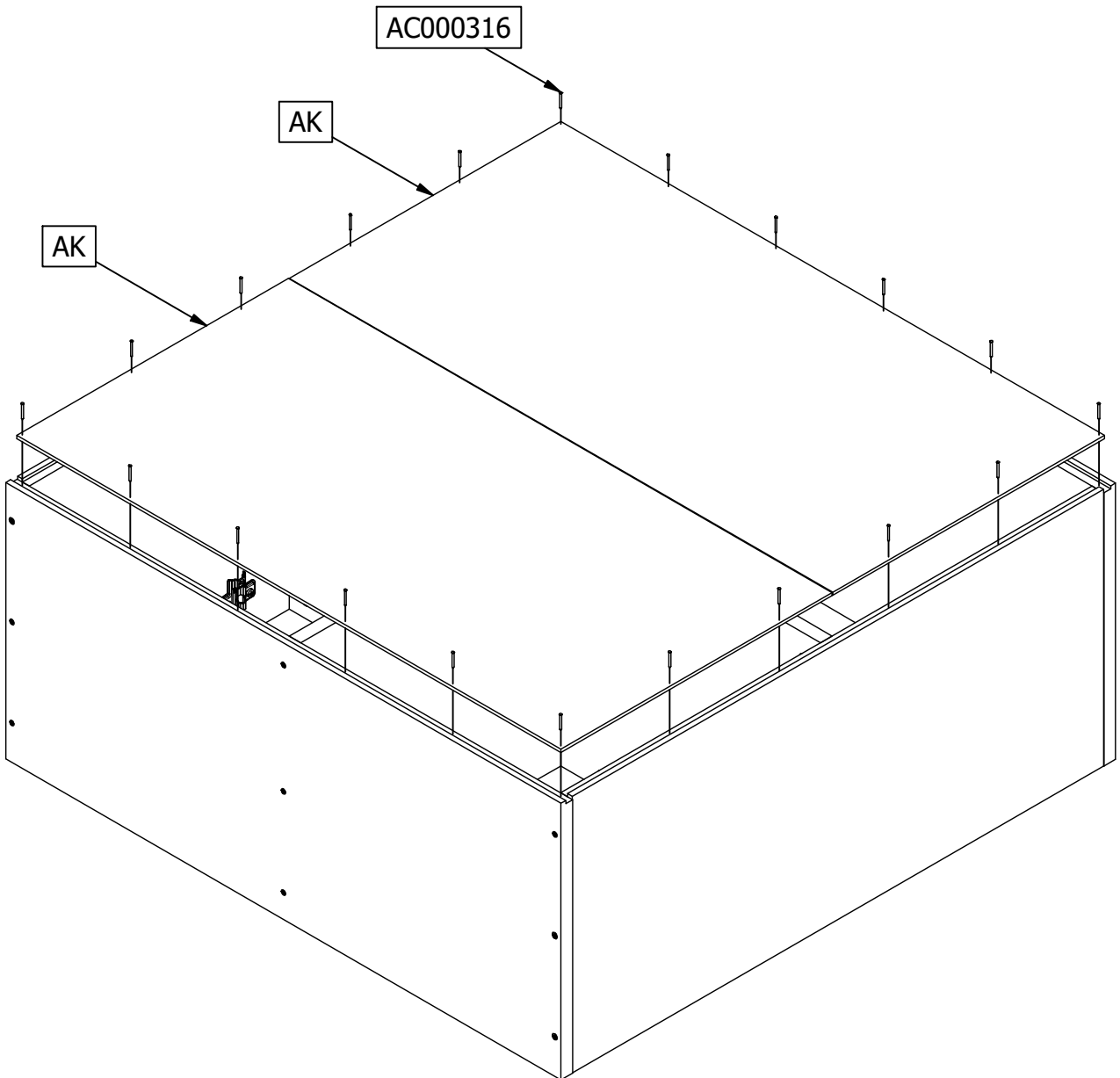
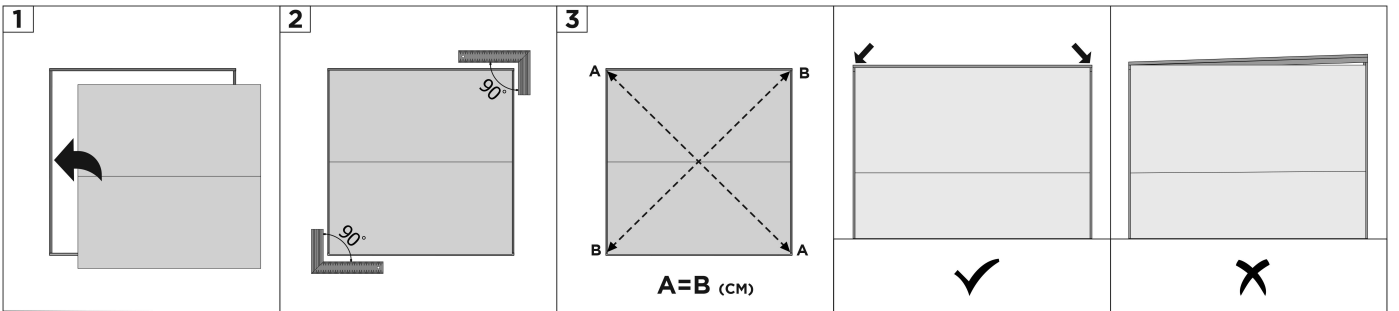
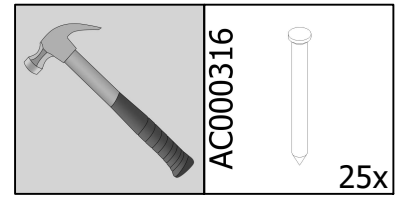

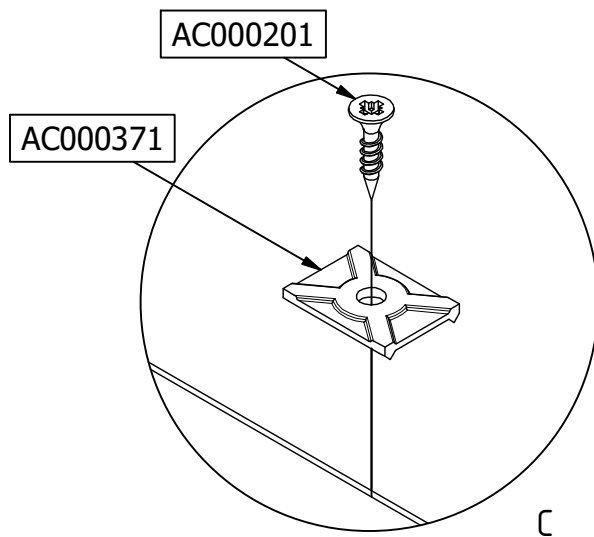
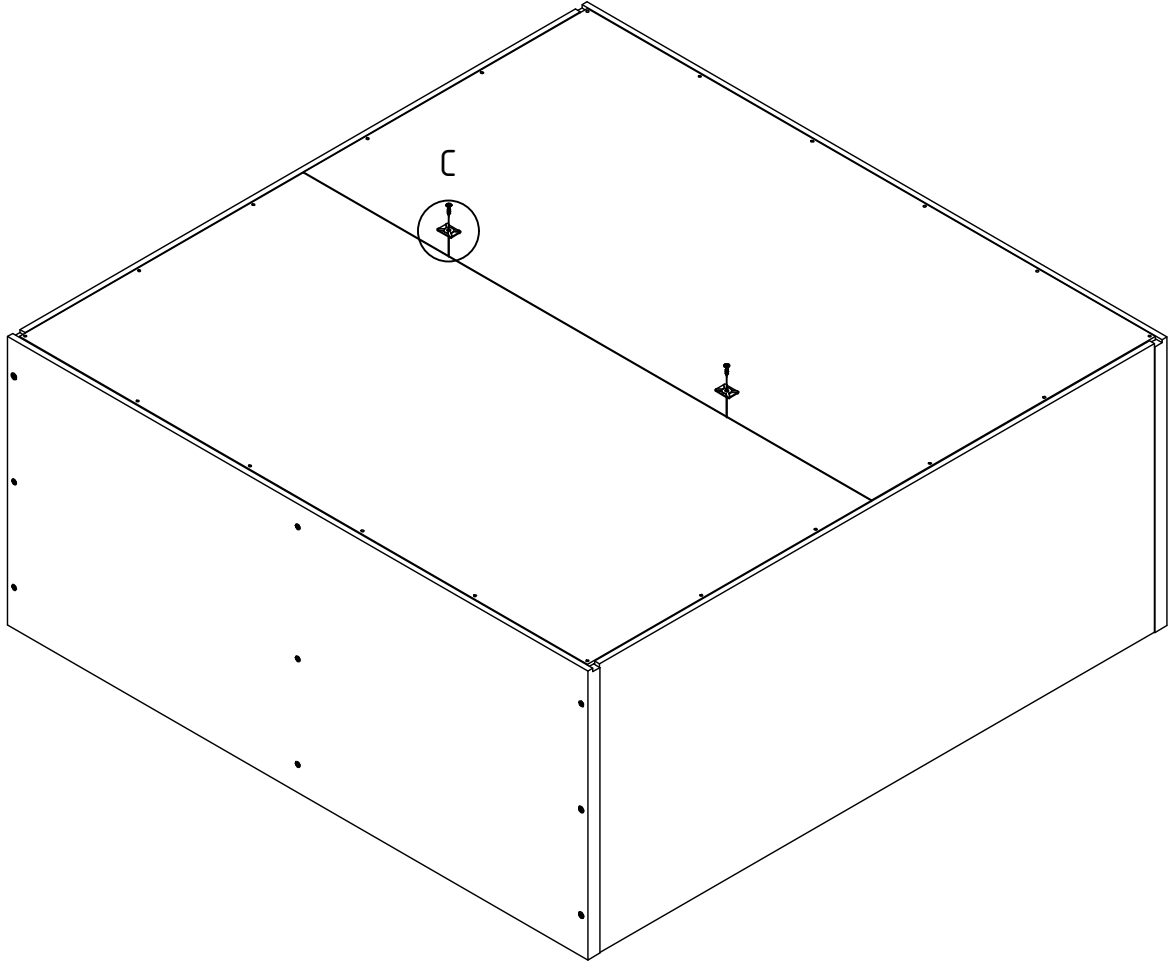
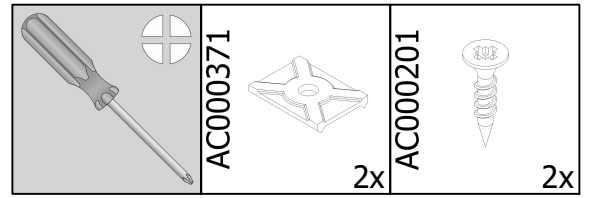



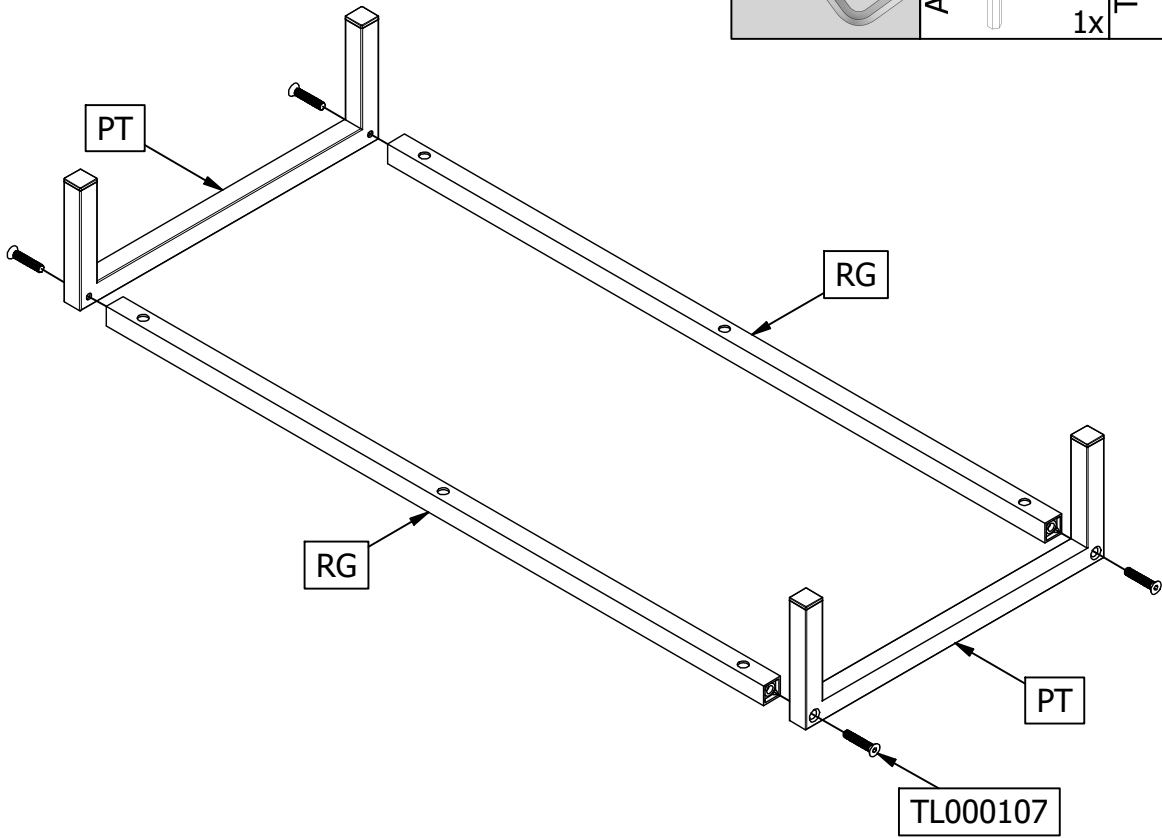
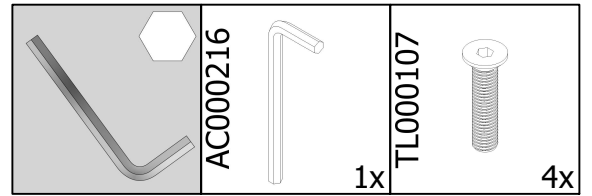

12

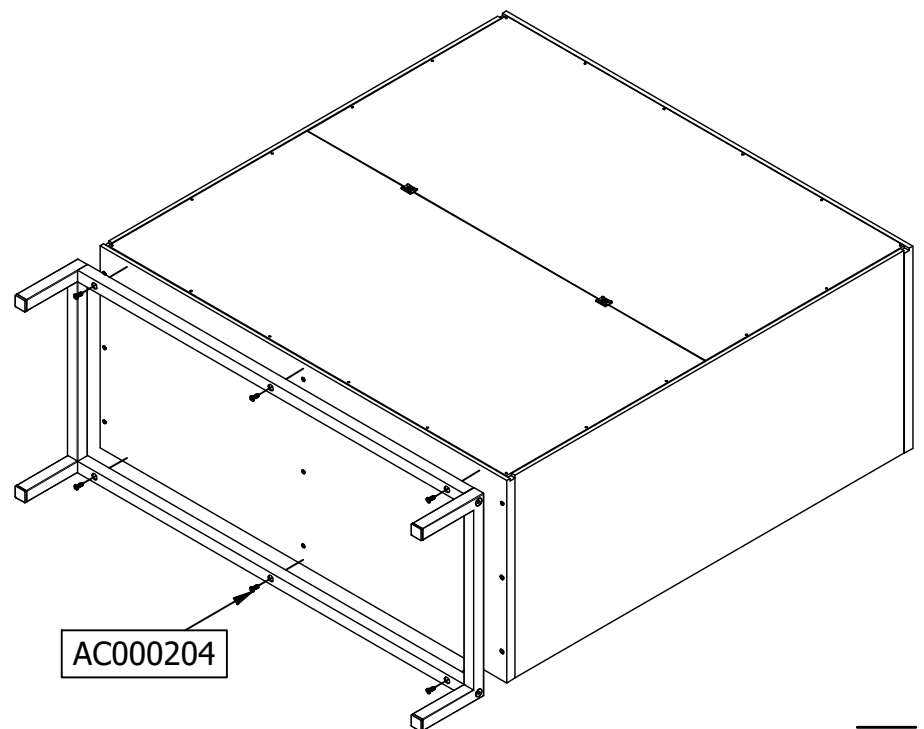
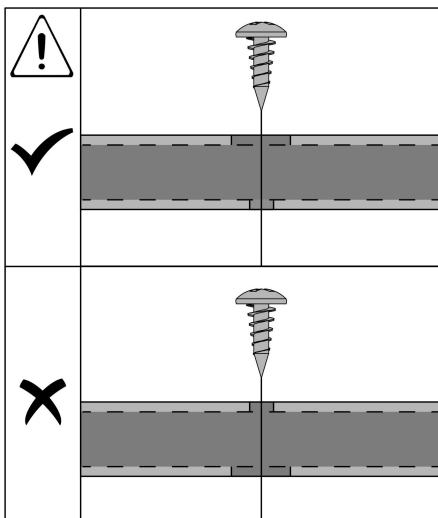
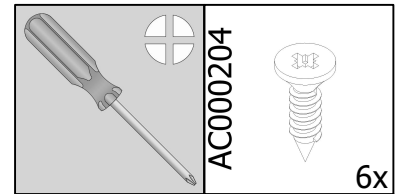

13

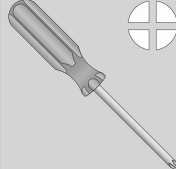

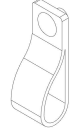
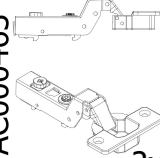

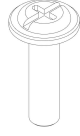

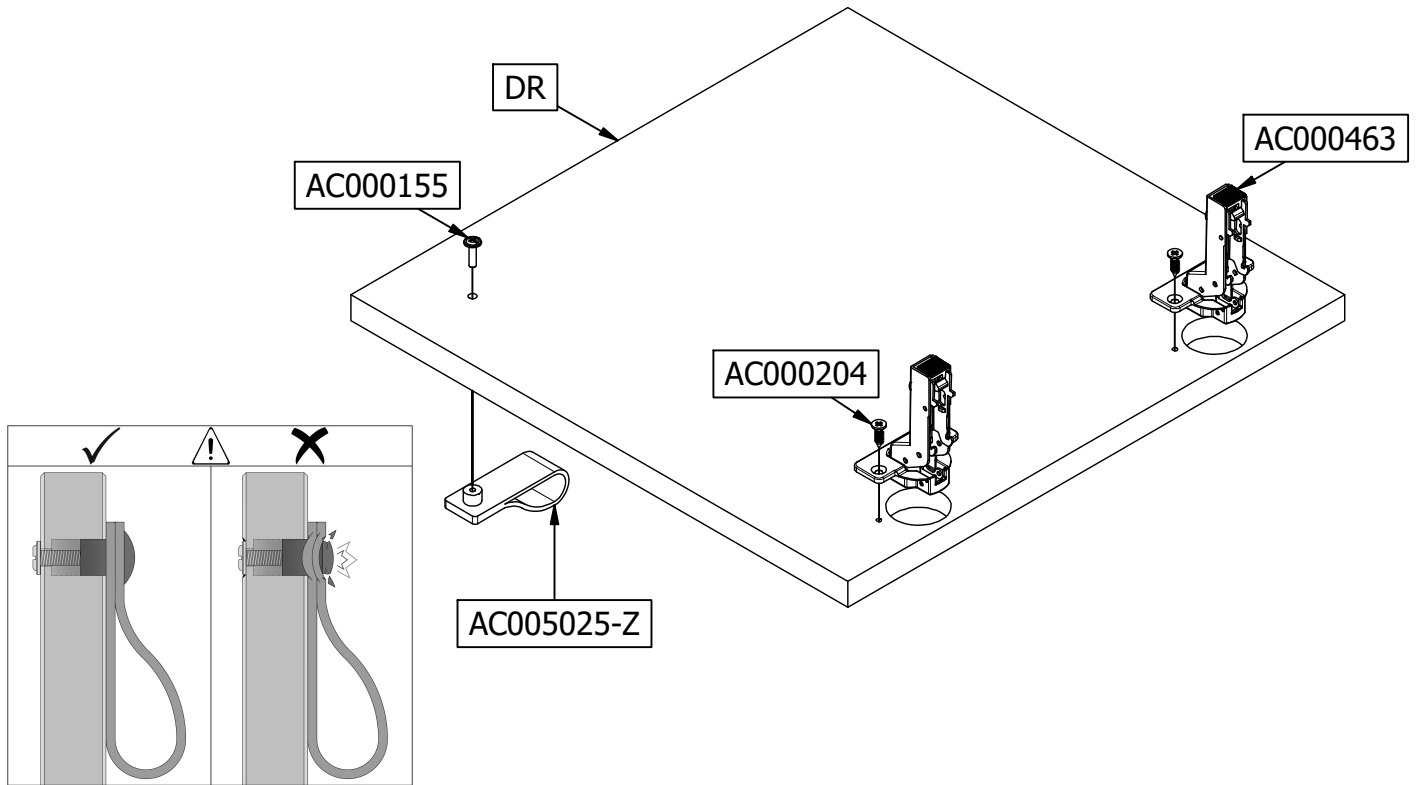
14

		AC005025-Z		1x	AC000463		2x	AC000204		4x	AC000155		1x
---	---	------------	---	----	----------	--	----	----------	---	----	----------	---	----

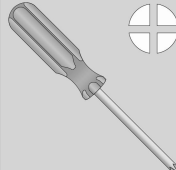

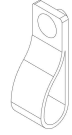
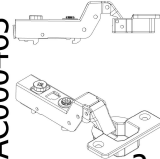
15

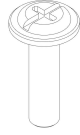
		AC005025-Z		1x	AC000463		2x	AC000204		4x	AC000155		1x
---	---	------------	---	----	----------	--	----	----------	---	----	----------	---	----

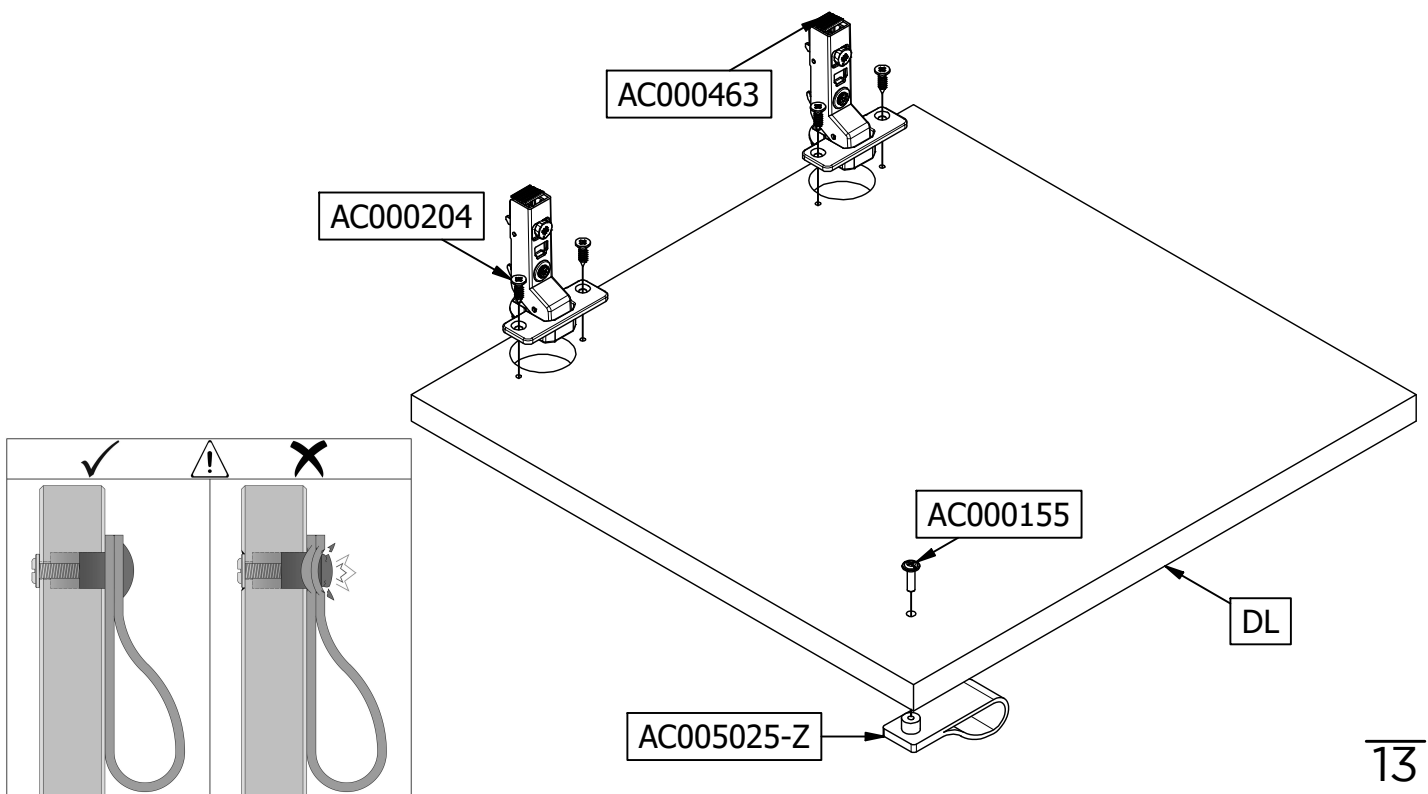

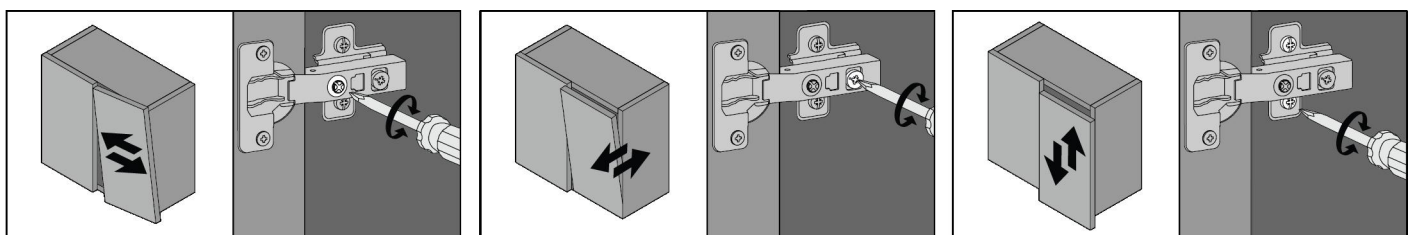
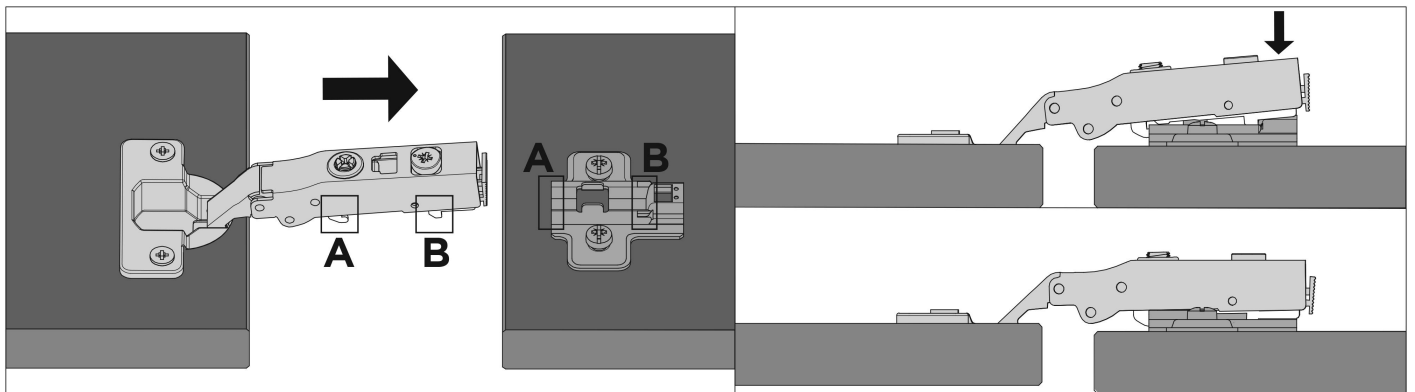
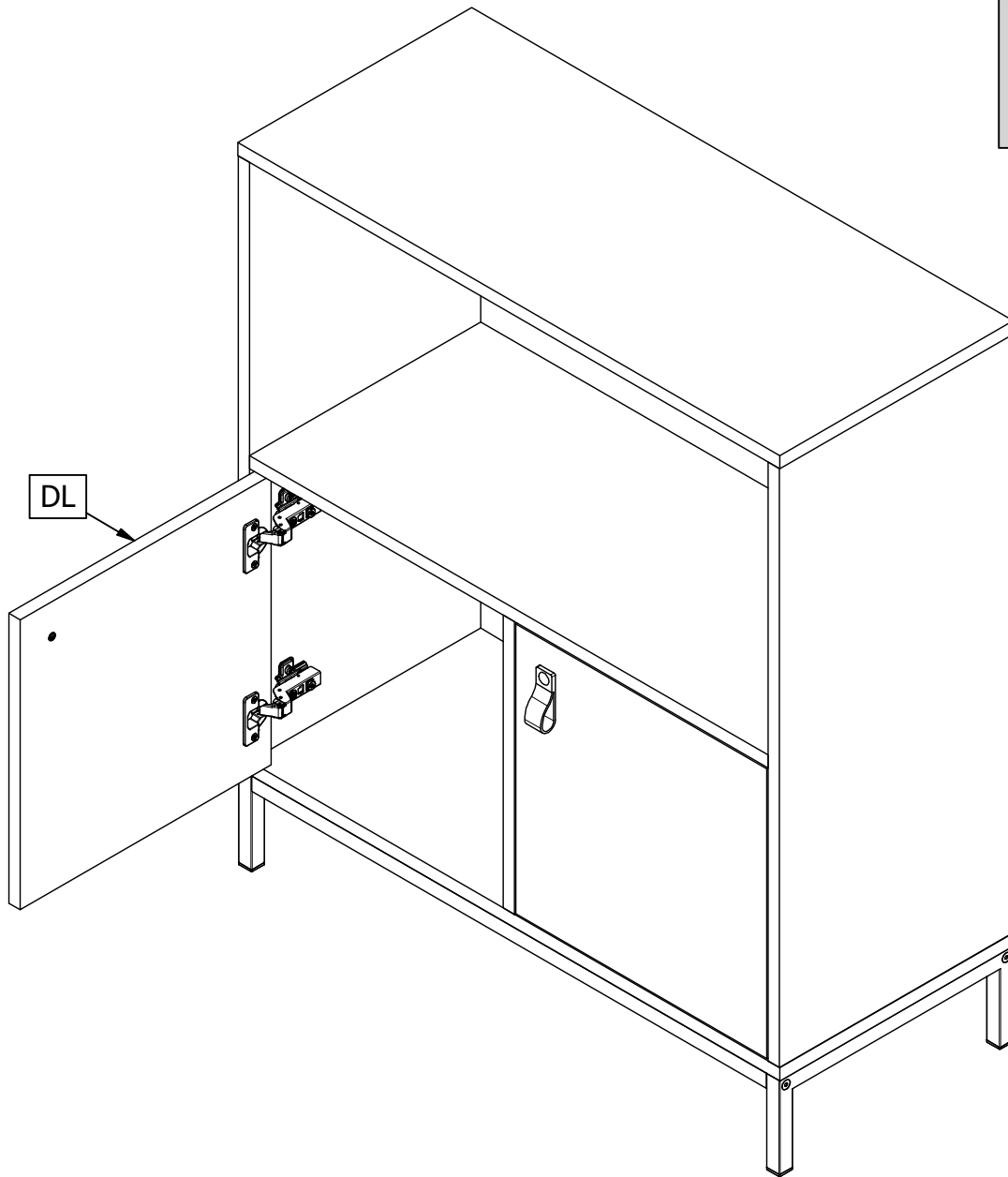
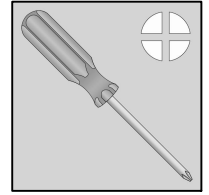

17

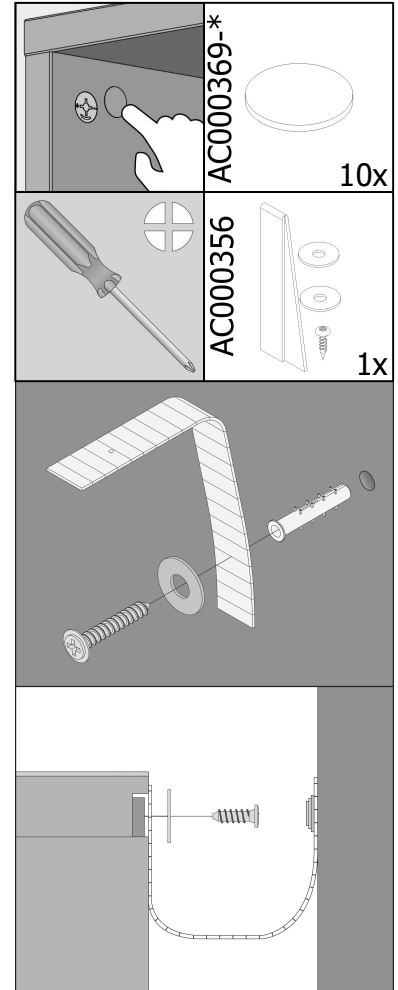
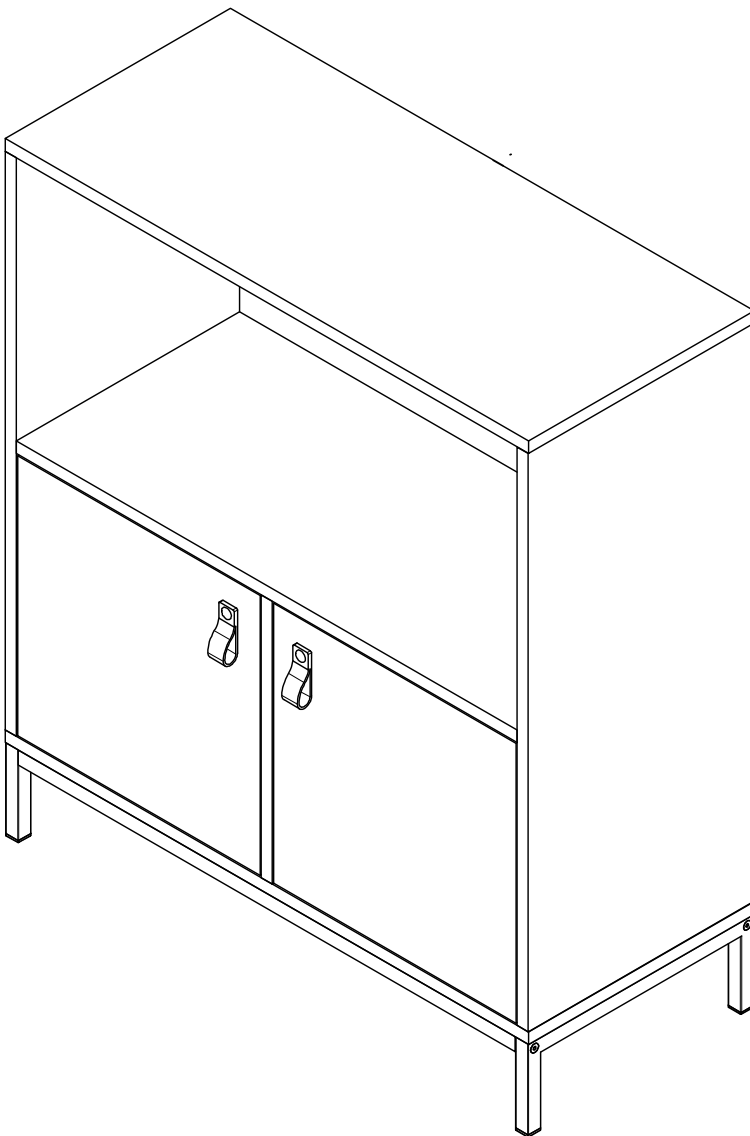
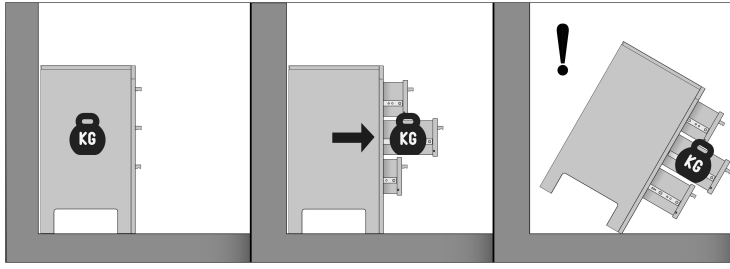

## SHARE HAPPINESS

Blij met je nieuwe vtwonen aanwinst? Style het thuis op jouw manier, maak een foto en deel op social media met **#vtwonenbijmijthuis**

We are curious about the result! Would you like to share it with us? Use **#vtwonenbijmijthuis** on social media.  
Wir sind gespannt auf das Ergebnis! Möchten Sie mit uns teilen? Benutzen Sie **#vtwonenbijmijthuis** in Social Media.  
Nous sommes impatient de connaître le résultat. Souhaitez-vous le partager avec nous?  
Utilisez **#vtwonenbijmijthuis** sur les médias sociaux.



[facebook.com/vtwonen](https://facebook.com/vtwonen)



[instagram.com/vtwonen](https://instagram.com/vtwonen)



[pinterest.com/vtwonen](https://pinterest.com/vtwonen)

**Bewaar deze handleiding • Please save this manual • Bitte bewahren Sie diese Montageanleitung • Merci de garder la notice de montage**

De Eekhoorn Dutch Furniture | Jan Tinbergenweg 1 | 1689 ZV Hoorn | The Netherlands