

Miley

sofa

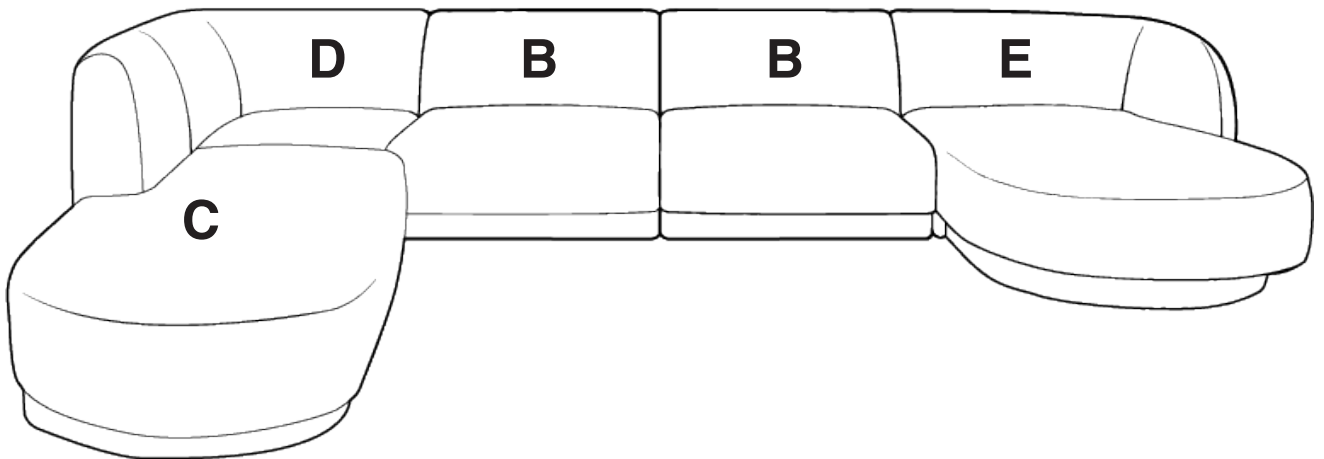
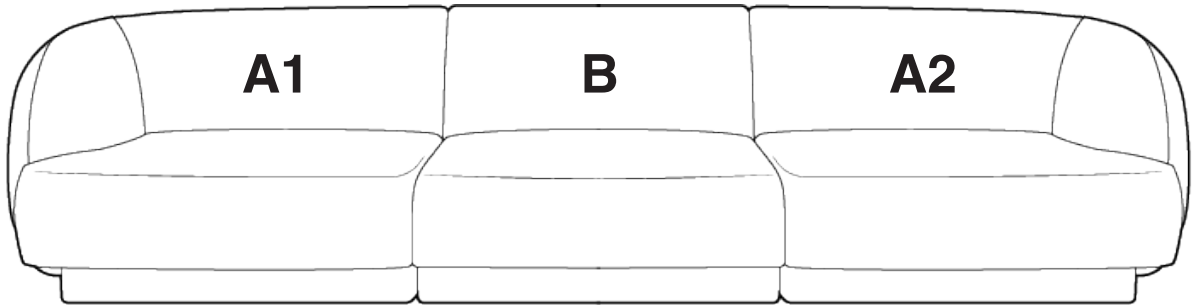
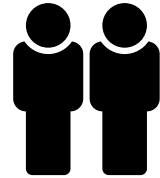

1 of 7

SHAPE UP ALL PILLOWS AND CUSHIONS!

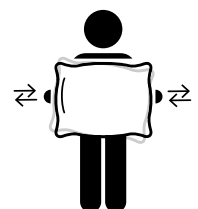

1: A1 + A2

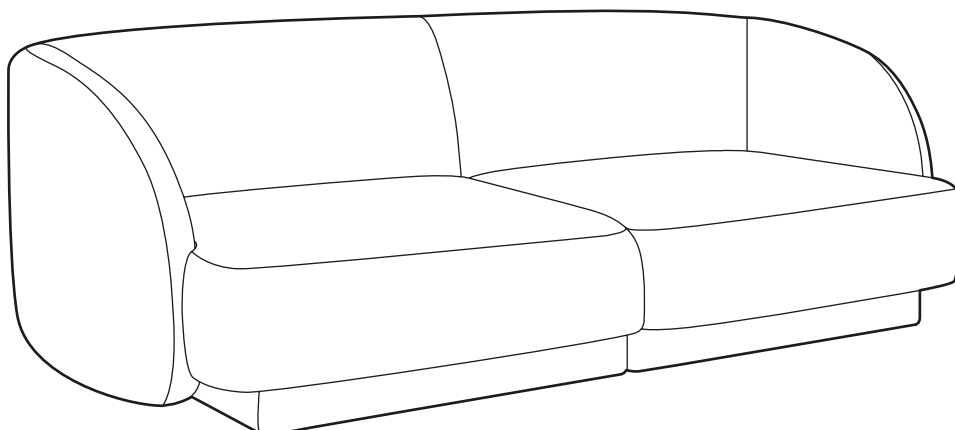
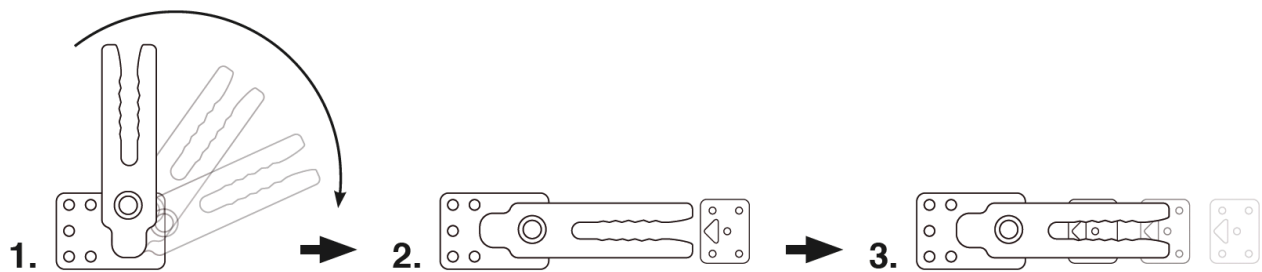
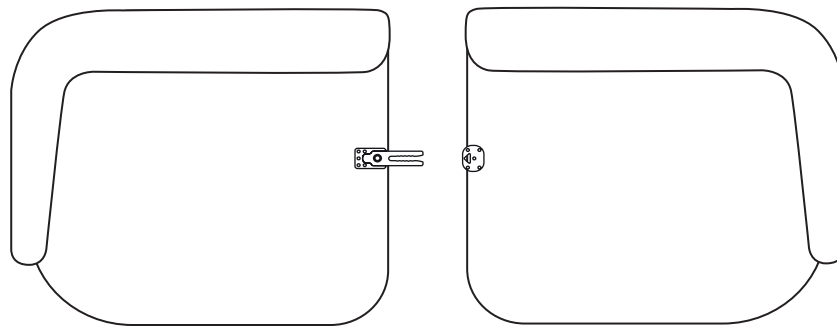
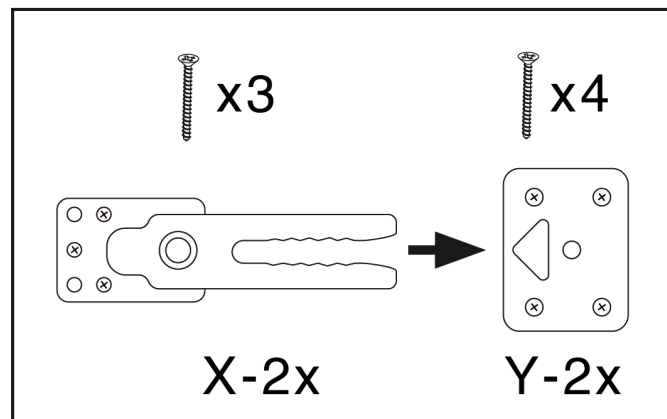

2: A1 + A2 + B

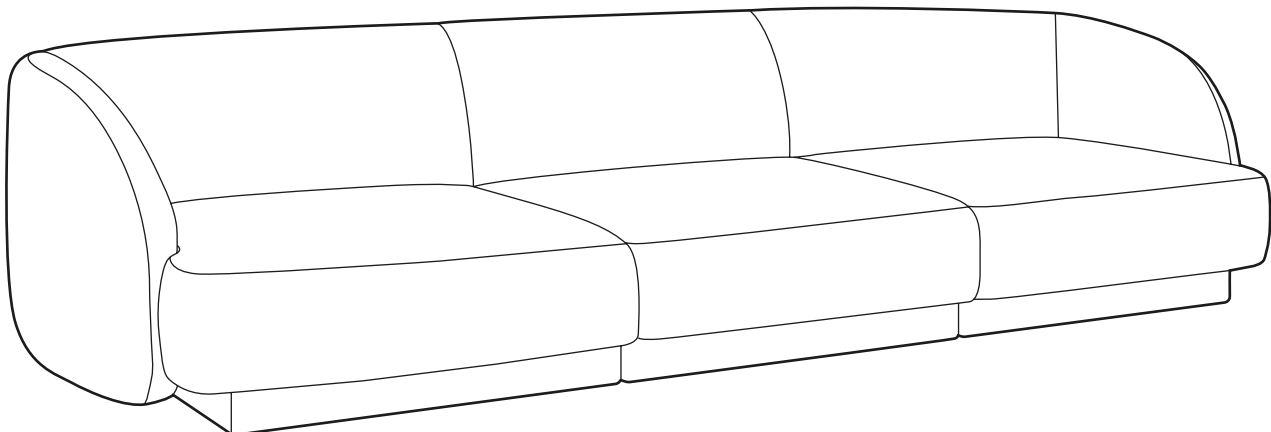
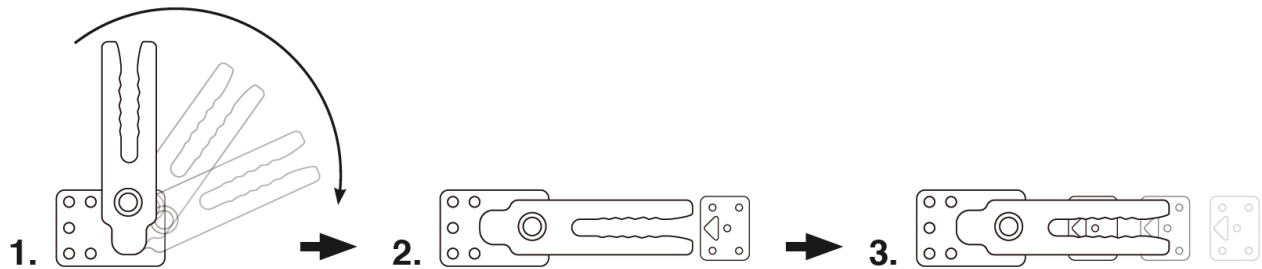
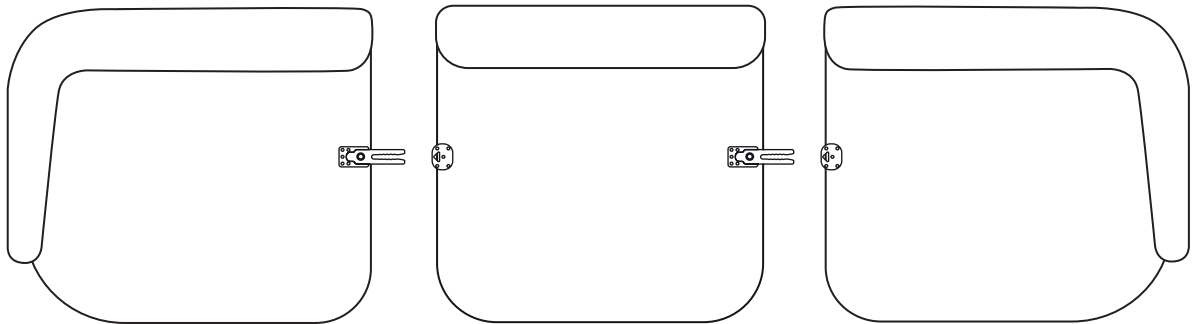
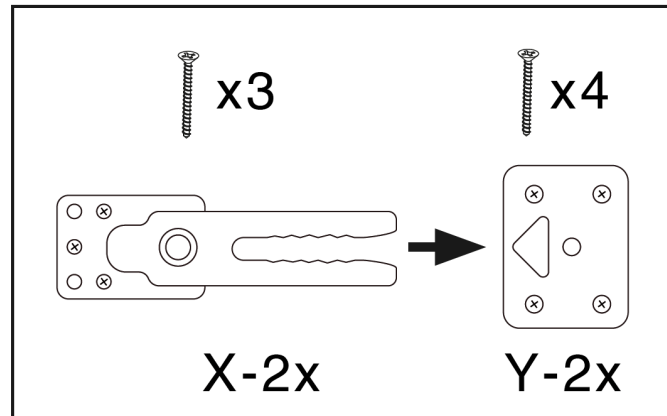

3: A1 + B + E

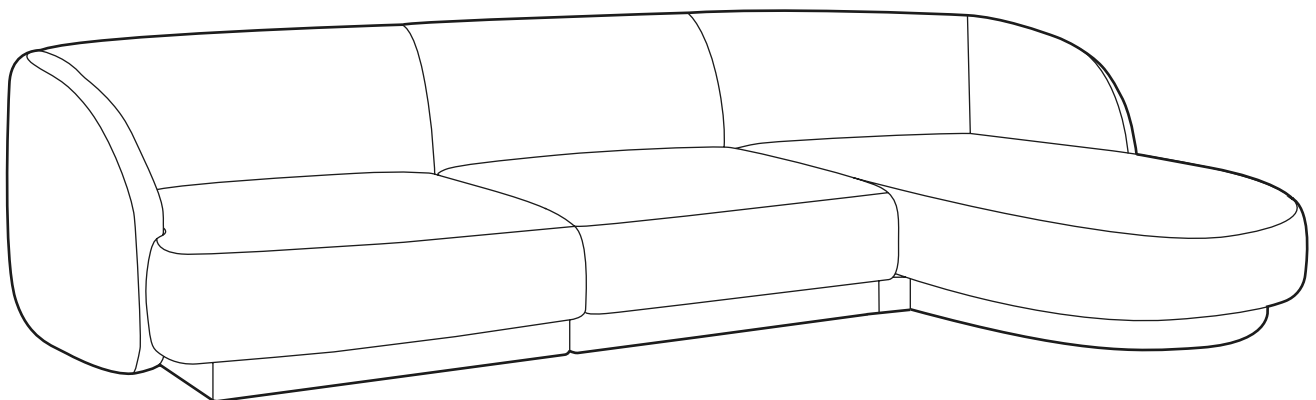
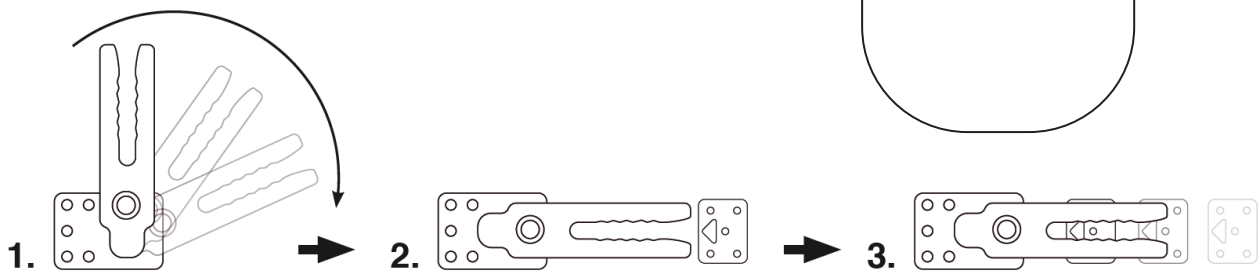
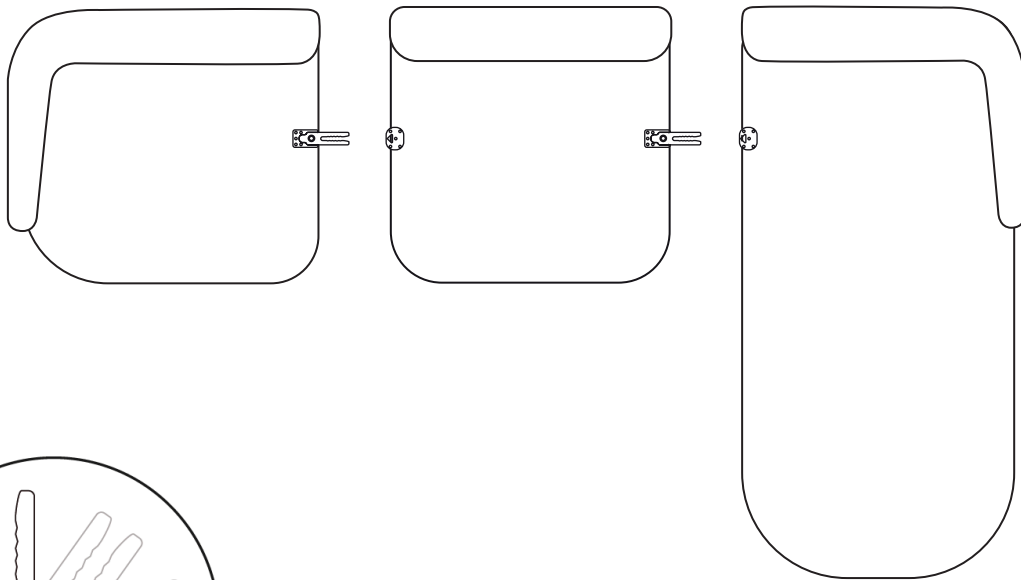
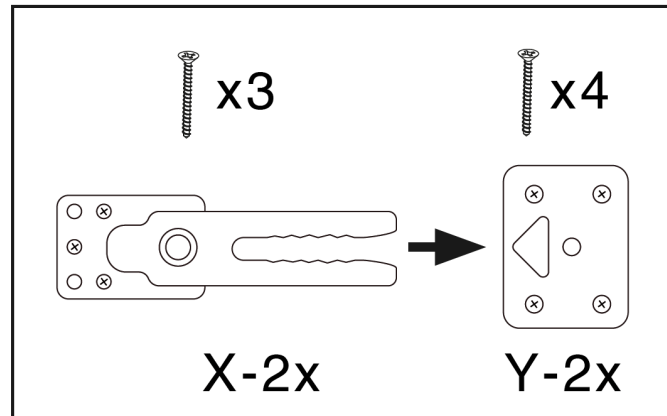

4: A1 + A2 + 2x B + D

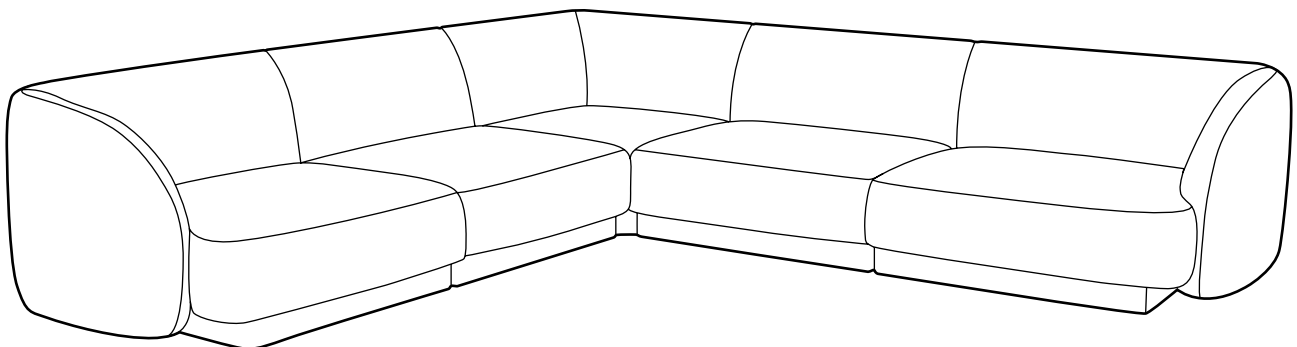
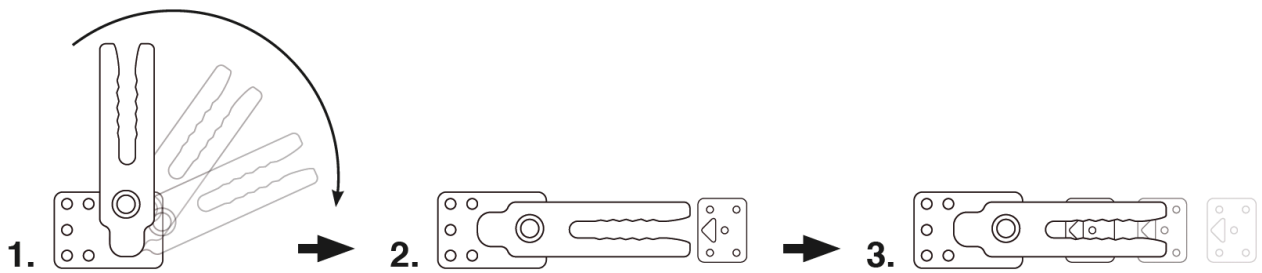
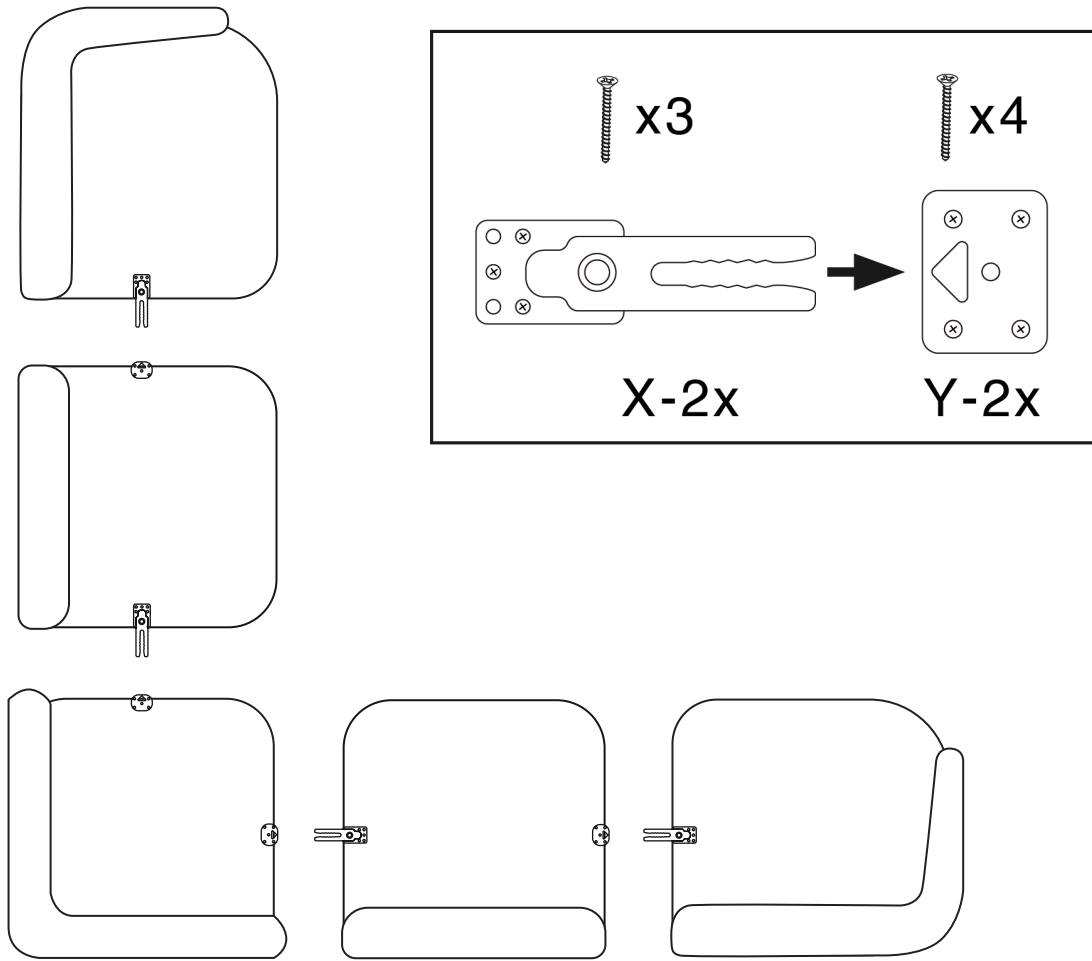

5: 2x B + C + D + E

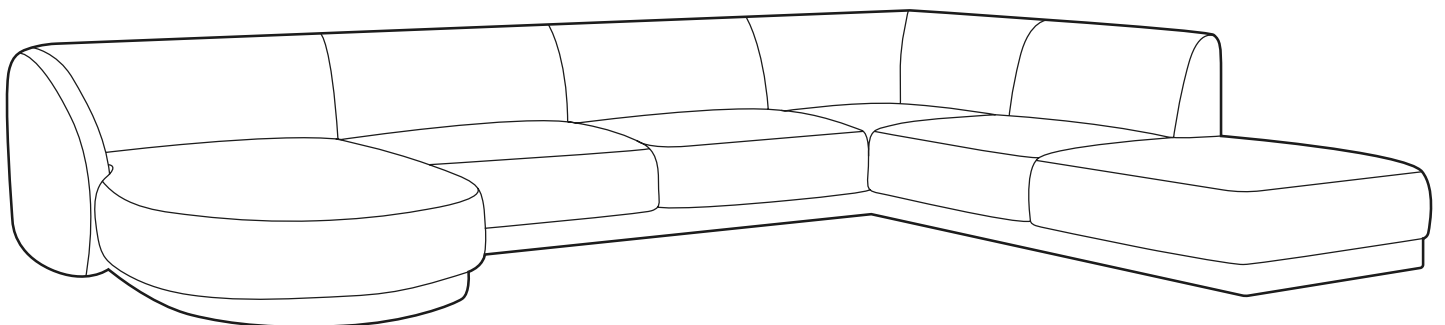
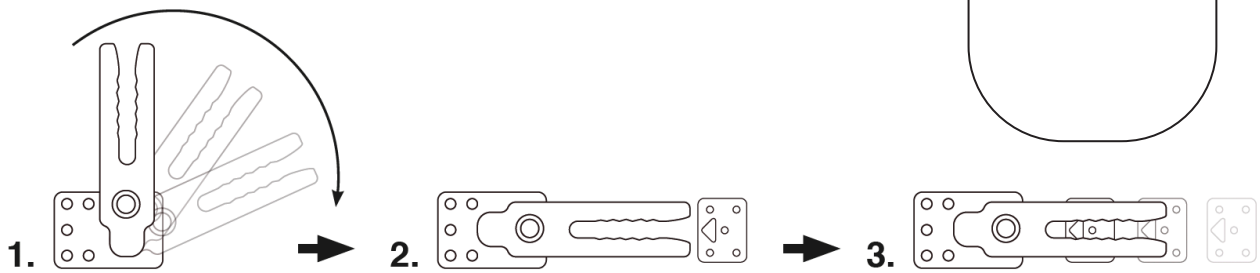
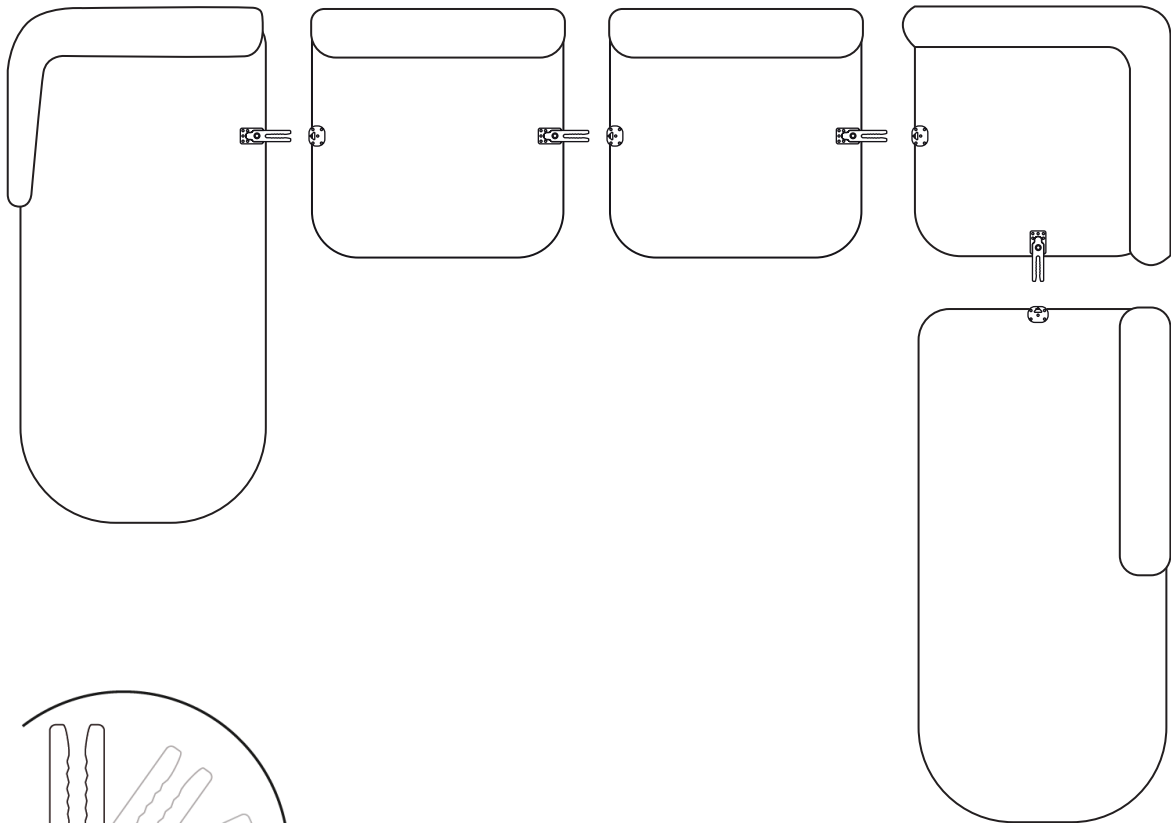
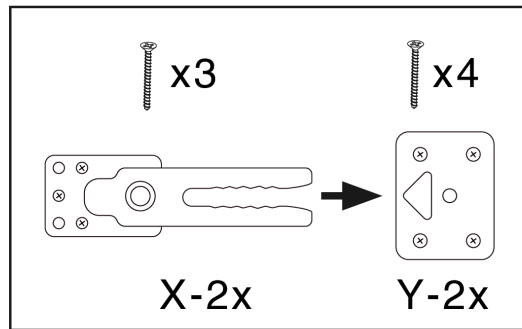

6: 2x B + 2x E

