

- INSTRUCTION MANUAL -

REVOLVER BAR STOOL

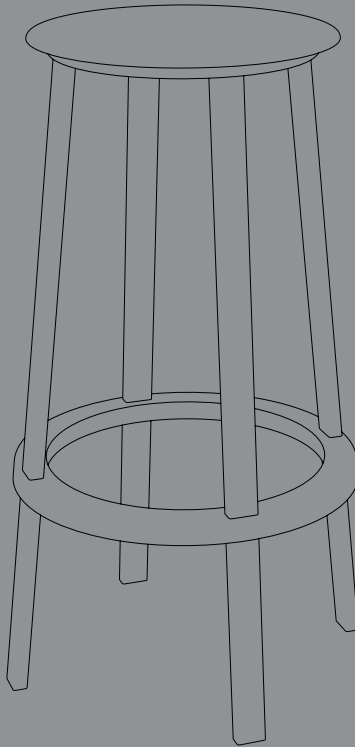

DESIGN BY LEON RANSMEIER

HAY

- PARTS -

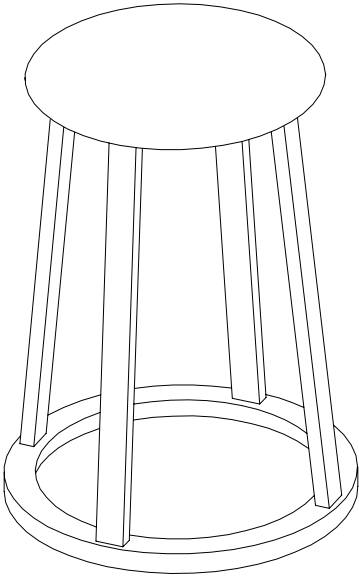

A Seat x1

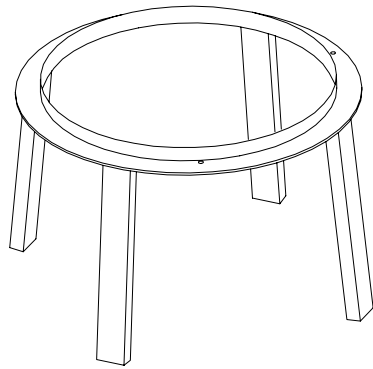

B Base x1

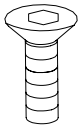

C Screw x4

1.

Place section **A** upside down on a protected surface. Now place section **B** upside down on top of section **A**, making sure the 6 holes on section **B** are aligned with the exposed bearing.

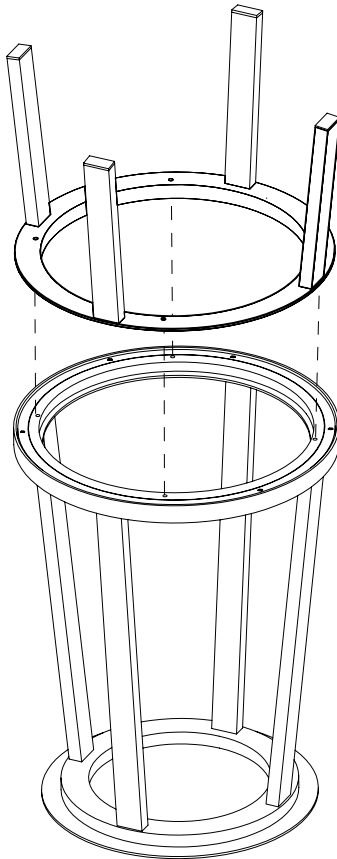

2.

Fix the two parts together using the bolts  provided, making sure that you partially tighten the bolts in turn until all of them have been fully tightened.

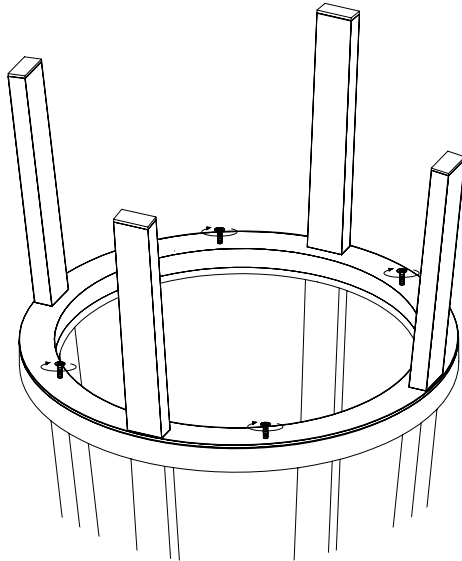

3.

Turn the bar stool over.

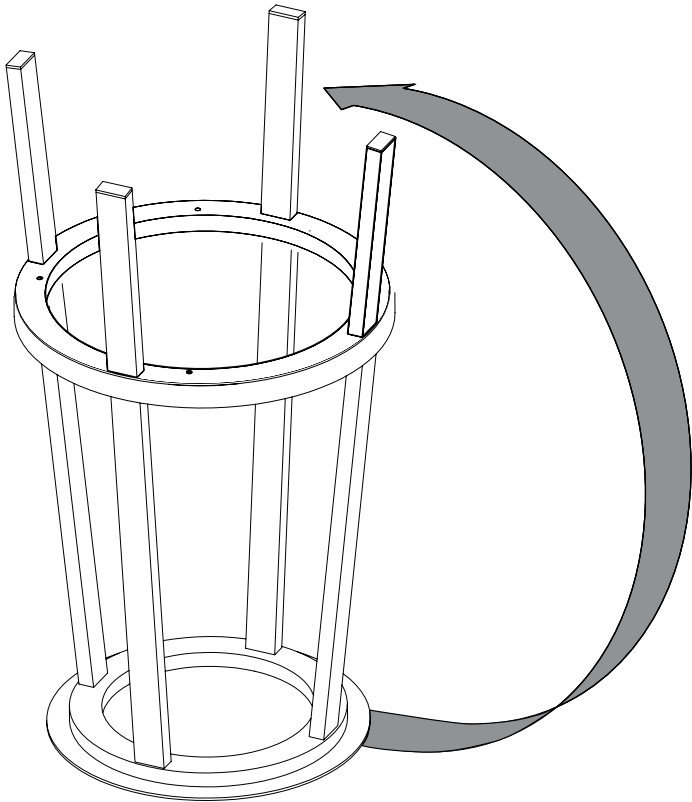

4.

Done!

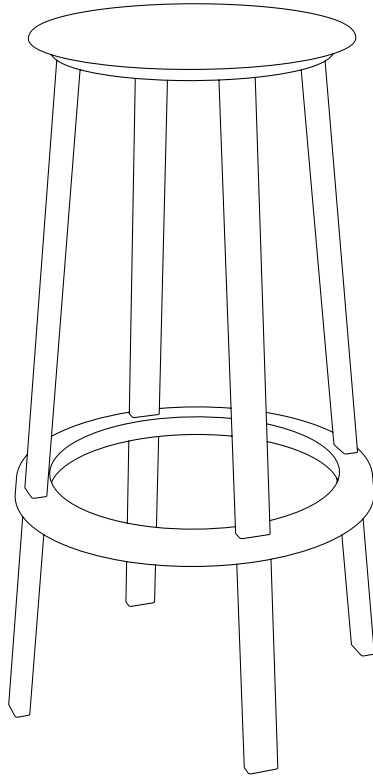

- CARE & MAINTENANCE -

Our Care & Maintenance offers guidance for optimal maintenance of your HAY product. It includes advice and instructions on cleaning and caring for specific materials to prolong the life of your furniture.



Please find our Care & Maintenance guide by scanning the QR code



You can find more relevant information on Revolver Bar Stool by scanning the QR code

You can also find the same information here
hay.dk/downloads

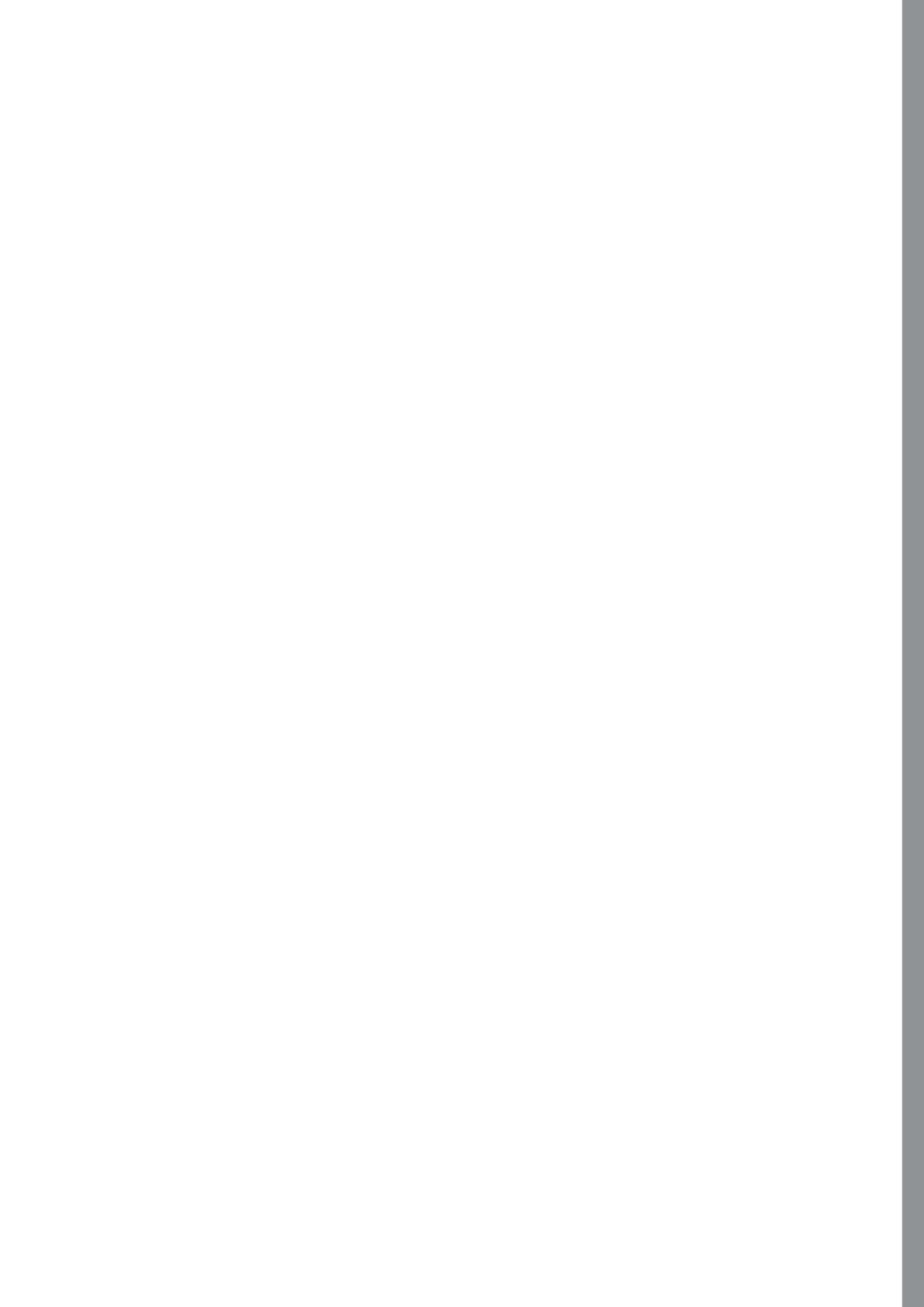

Havnen 1 8700 Horsens Denmark
+45 3164 6000 / hay@hay.com

10/01/2023

HAY